

EN Operating and installation instructions CFI 1 1

Surface induction glass ceramic cooktop with 2 cooking zones

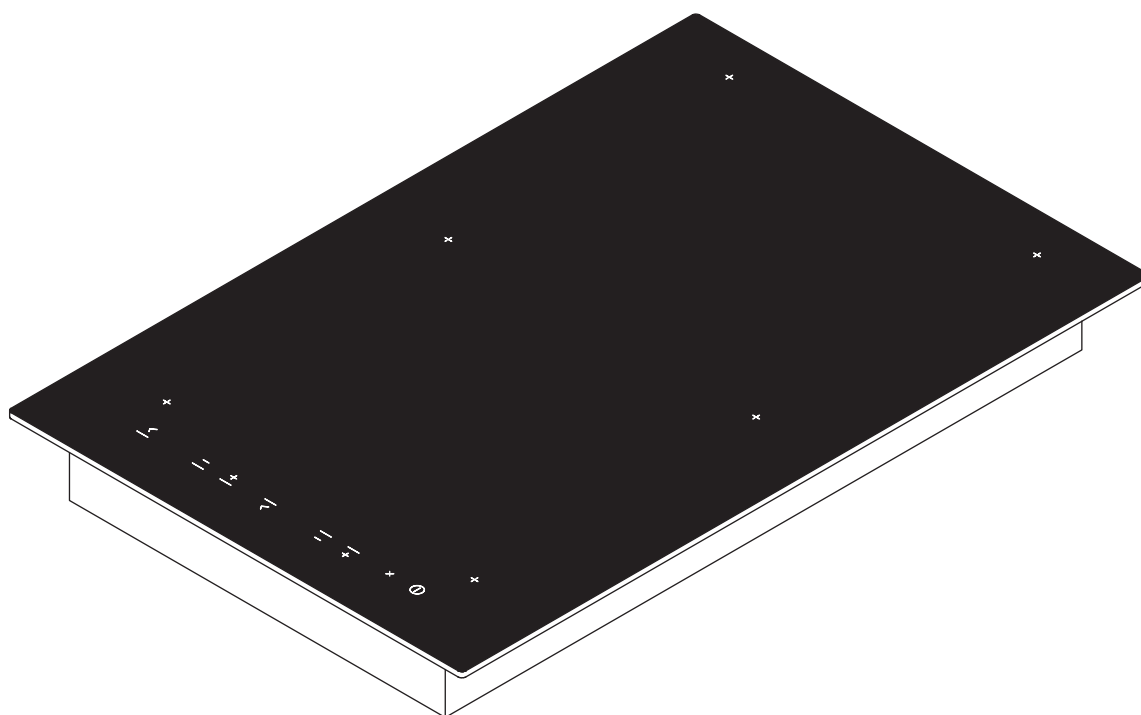

CFI 1 1UMEN-002

Operating and installation instructions:

Original

Translation

Manufacturer

BORA Vertriebs GmbH & Co KG

Innstraße 1
6342 Niederndorf
Austria

Contact

T +43 (0) 5373 / 62250-0
mail@bora.com
www.bora.com

The distribution and duplication of this document, as well as the use and disclosure of its contents are prohibited unless expressly authorised.

These operating and installation instructions have been drawn up with the greatest of care. But it cannot be ruled out that subsequent technical modifications have not yet been incorporated or the relevant content has not yet been adapted. Please accept our apologies in this eventuality. An updated version can be requested from the BORA Service Team. Subject to printing errors and mistakes.

© BORA Vertriebs GmbH & Co KG

All rights reserved.

Table of Contents

1	General information	4	6	Operation	20
1.1	Target group.....	4	6.1	Switching cooktop on/off	20
1.2	Validity of the operating and installation instructions...	4	6.1.1	Switching on the cooking zone	20
1.3	Other applicable documents	4	6.1.2	Adjusting the power level	20
1.4	Presentation of information.....	5	6.1.3	Changing the power level	20
2	Safety	6	6.1.4	Switching on the power setting.....	20
2.1	General safety instructions.....	6	6.1.5	Switching the power setting off early.....	20
2.2	Safety instructions – operation	7	6.1.6	Switching off the cooking zone	20
2.3	Safety instructions – installation	9	6.1.7	Pause function	20
2.4	Safety instructions – disassembly and disposal	10	6.1.8	Bridging function.....	21
2.5	Safety instructions – spare parts	10	6.1.9	Automatic heat up function	21
2.6	Intended use	10	6.1.10	Heat retention level	21
3	Technical data	11	6.1.11	Using the timer function.....	21
4	Device description	12	6.1.12	Activating/deactivating the childproofing feature...22	
4.1	Structure	12	7	Cleaning and Maintenance	23
4.2	Operating panel and operating principle.....	12	7.1	Cleaning agents	23
4.3	Functional principle.....	13	7.2	Maintaining the cooktop.....	23
4.3.1	Power levels	13	7.3	Cleaning the cooktop.....	23
4.3.2	power setting	13	8	Troubleshooting	24
4.3.3	Automatic heat up function.....	13	9	Decommissioning, disassembly	
4.3.4	Heat retention level	13		and disposal	25
4.3.5	Bridging function.....	13	9.1	Decommissioning.....	25
4.3.6	Pan detector.....	13	9.2	Disassembly	25
4.3.7	Pause function	14	9.3	Environmentally-friendly disposal.....	25
4.3.8	Timer functions	14	10	Warranty, technical service, spare parts	26
4.3.9	Suitable cookware	14	10.1	Warranty.....	26
4.4	Safety devices.....	14	10.2	Service.....	26
4.4.1	Residual heat display.....	14	10.3	Replacement parts.....	26
4.4.2	Safety shut-down of the cooking zone.....	14			
4.4.3	Overheating protection	15			
4.4.4	Automatic switch-off if the button is pressed and held.....	15			
4.4.5	Child safety lock.....	15			
5	Installation	16			
5.1	Checking the scope of delivery	16			
5.2	Tool and aids.....	16			
5.3	Assembly instructions.....	16			
5.3.1	Safety clearances.....	16			
5.3.2	Work surface and kitchen units.....	16			
5.3.3	Cooktop air intake	16			
5.4	Cut-out dimensions.....	17			
5.5	Installing the cooktop	18			
5.6	Power connection	19			
5.7	Handover to user	19			

1 General information

1.1 Target group

These operating and installation instructions apply for the following target groups:

Target group	Requirements
User	The appliance can be used by children aged 8 and above as well as people with reduced physical, sensory or mental capacities or a lack of experience and/or knowledge if they are supervised or have been instructed how to safely use the appliance and understand the resultant risks. Children must be supervised. All safety and warning information and the handling instructions in the installation instructions must be complied with.
Ambitious DIYers	Ambitious DIYers can independently conduct all joinery and installation work providing they possess the necessary skills and expertise. They must never independently establish electricity and gas connections.
Installation specialists	Installation specialists are authorised to conduct all joinery and installation work in line with existing regulations. The electricity and gas connections must be certified by a certified engineer for the applicable trade prior to commissioning.
Electricians	The electrical connection may only be established by a certified engineer. He/she also assumes responsibility for the proper electrical installation and commissioning.
Gas specialists	The gas connection may only be established by certified engineers. They also assume responsibility for proper installation and commissioning of the gas system.

Tab. 1.1 Target groups

INFO BORA Holding GmbH, BORA Vertriebs GmbH & Co KG, BORA APAC Pty Ltd and BORA Lüftungstechnik GmbH - hereinafter referred to as BORA - do not assume any liability for damage arising from non-adherence to these documents and from improper assembly! The electricity and gas connections must be made by a qualified specialist. Installation must comply with the valid standards, regulations and laws. All safety and warning information and the operating and installation instructions must be complied with.

1.2 Validity of the operating and installation instructions

These instructions apply to several device versions. It is therefore possible that some of the features described do not apply to your appliance.

1.3 Other applicable documents

These operating and installation instructions are valid in conjunction with other documents, which must be adhered to.

Please be sure to adhere to all documents that form part of the scope of delivery.

INFO BORA accepts no liability for damage caused by failure to comply with these documents!

Directives

This device meets the following EU/EC directives:

2014/30/EU EMC Directive
 2014/35/EU Low Voltage Directive
 2009/125/EC Ecodesign Directive
 2011/65/EU RoHS Directive
 2012/19/EU WEEE Directive

1.4 Presentation of information

To make working with these instructions quick and easy, consistent formatting, numbering, symbols, safety instructions, terms and abbreviations are used throughout.

Handling instructions are marked with an arrow.

- ▶ Always carry out handling instructions in the sequence shown.

Bullet points are indicated by a square bullet point at the edge of the line.

- Bullet point 1
- Bullet point 2

INFO Information points out specific points you must always comply with.

Safety and warning information

The safety and warning information in these instructions are highlighted with symbols and signal words.

Safety and warning information is structured as follows:

WARNING SYMBOL AND SIGNAL WORD!



Type and source of the danger

Consequences of non-compliance

- ▶ Measures to minimise risk
-

The following applies:

- The warning symbol draws attention to the danger.
- The signal word indicates the severity of the risk.

Warning sign	Signal word	Hazard
	Danger	Indicates an imminent hazardous situation which could lead to death or serious injury if ignored.
	Warning	Indicates an imminent hazardous situation which could lead to death or serious injury if ignored.
	Caution	Indicates a potentially hazardous situation which could lead to slight or minor injuries if ignored.
–	Caution	Indicates a situation which could result in material damage if ignored.

Tab. 1.2 Meaning of warning symbols and signal words

2 Safety

2.1 General safety instructions

INFO The appliance complies with the stipulated safety requirements. The user is responsible for appliance cleaning and maintenance as well as its safe use. Improper use can lead to personal injury and damage to property.

- The operating and installation instructions contain important information about installation and operation. These enable you to protect yourself against injuries and prevent damage to the appliance. Contact details for further information as well as application and usage questions can be found on the back of these operating and installation instructions.
- The term device applies to cooktops, cooktop extractors and cooktops with cooktops extractors.
 - ▶ Read the operating and installation instructions fully before using the appliance for the first time.
 - ▶ Always store the operating and installation instructions within easy reach so that they can be accessed if required.
 - ▶ Pass the operating and installation instructions to the next owner if you sell the appliance.
 - ▶ Conduct all work extremely attentively and conscientiously.
 - ▶ Check the appliance for visible damage when unpacking it.
 - ▶ Do not connect a damaged appliance.
 - ▶ Only use the appliance once all installation activities are complete. This is the only way to ensure safe operation.
 - ▶ Make sure that hot hobs are not touched.
 - ▶ Avoid boiling over.
 - ▶ Pay attention to the residual heat display.
 - ▶ Switch the device off after use.
 - ▶ Do not rely on the pan size recognition.
 - ▶ Keep pets away from the appliance.

CAUTION!

Risk of injury from falling device components!

Falling device components such as pan supports, control elements, covers, grease filters, etc. can cause injuries.

- ▶ Place device components safely near the devices after you remove them.
 - ▶ Make sure that none of the device components you have removed could fall.
-

Recirculation mode

INFO When cooking, additional moisture is released into the ambient air.

INFO In recirculation mode, only a slight amount of moisture is removed from the cooking vapour.

- ▶ When using recirculation mode, ensure a sufficient supply of fresh air, e.g. by opening a window.
- ▶ Ensure a normal and comfortable room climate (humidity of 45–60%), e.g. by opening natural ventilation openings or using domestic ventilation systems.
- ▶ After every use in recirculation mode, switch the cooktop extractor to a low level for about 20 minutes or activate the automatic after-run function.

Effect on pacemakers, hearing aids and metallic implants

INFO Induction cooktops generate a high-frequency electromagnetic field near the cooking zones. Coming too close to the cooking zones could have a negative influence or even cause malfunctions of pacemakers, hearing aids or metallic implants. Issues with pacemakers are unlikely.

- ▶ In case of doubt, please contact the manufacturer of your medical device or your doctor.

Households with children and people with special needs

- ▶ The appliance can be used by children aged 8 and above as well as people with reduced physical, sensory or mental capacities or a lack of experience and/or knowledge if they are supervised or have been instructed how to safely use the appliance and understand the resultant risks.
- ▶ Supervise children in the vicinity of the appliance.
- ▶ Children must not play with the appliance.
- Use the childproofing feature to prevent children accidentally switching the cooktop on or changing the settings.
- ▶ Do not store any items that could be of interest to children in storage spaces above or behind the appliance. Children will otherwise be encouraged to climb on the appliance.
- ▶ Keep children and other people away from hot hobs.

Unauthorised modifications

Unauthorised modifications can cause the appliance to pose risks.

- ▶ Do not conduct any modifications to the appliance.

Cleaning and maintenance

The device must be cleaned regularly. Dirt can lead to damage or the buildup of odours. Remove any dirt immediately.

- Cleaning and maintenance work must not be carried out by children unless they are supervised at all times.

- ▶ Do not use steam cleaners. The steam can cause a short-circuit on live parts and cause damage to property (see Cleaning and maintenance section).
- ▶ Do not put hot cookware near the control panel so as not to damage the electronics underneath.
- ▶ Make sure no water penetrates inside the device when cleaning. Only use a slightly damp cloth. Never spray water on the device. Water ingress can cause damage!
- ▶ Where possible, clean the cooktop after every cooking session.
- ▶ Only clean the cooktop when it has cooled down.
- ▶ For cleaning, only use non-abrasive detergents to avoid scratching or wearing the surface.
- ▶ Make sure the base of the cookware and the cooking zone are clean and dry.
- ▶ Always lift the cookware (do not pull) to avoid scratching or wearing the surface.

2.2 Safety instructions – operation

Cooktop



DANGER!

Unsupervised cooktops are a fire risk!

Oil and fat can heat up and catch fire quickly.

- ▶ Never leave hot oil or fat unattended.
- ▶ Never attempt to extinguish burning oil or fat with water.
- ▶ Stifle the fire using a lid, for example.



DANGER!

Risk of explosion caused by flammable liquids!

Flammable liquids in the vicinity of the cooktop can explode and cause serious injury.

- ▶ Do not place any flammable liquids in the vicinity of the cooktop.
-



DANGER!
Risk of electric shock!

Chips, cracks or breaks in the glass ceramic panel can expose or damage the electronics underneath. This can lead to an electric shock.

- ▶ If the glass ceramic panel gets chipped, broken or cracked, switch the cooktop off immediately.
- ▶ Securely disconnect the appliance from the mains using LS switches, fuses, automatic circuit breakers or contactors.



WARNING!
Risk of burns from hot cooktop!

The cooktop and its exposed areas get hot during use. Once the cooking zone is switched off, it takes a little while to cool down below 60 °C. Touching hot surfaces can cause serious burns.

- ▶ Never touch the cooktop when it is hot.
- ▶ Keep children away from the cooktop when it is hot or ensure they are supervised at all times.



WARNING!
Leaving items on the cooking surface is a fire risk!

The cooktop and its touchable parts are hot when the cooking zone is switched on and during the cooling phase. Objects on the cooktop can get hot and catch fire.

- ▶ Do not place any items on the cooktop.



WARNING!
Risk of burns from hot items!

The cooktop and its touchable parts are hot during both operation and the cooling phase. Items placed on the cooktop heat up very quickly and can cause severe burns. This particularly applies to metal items (e.g. knives, forks, spoons, lids or cooktop extractor covers).

- ▶ Do not place any items on the cooktop.
- ▶ Please use suitable tools (pot holders, oven gloves).



WARNING!
Risk of burns from hot cookware!

Handles projecting over the edge are enticing for children to grab.

- ▶ Do not turn pot and pan handles so they stick out beyond the work surface.
- ▶ Make sure that children cannot pull hot pots and pans over.
- ▶ A special stove guard for children (available from specialist suppliers) reduces the risk.



WARNING!
Risk of getting burnt!

Liquid between the cooking zone and the pan base can evaporate and cause burns.

- ▶ Make sure that the cooking zone and the pan base are always dry.

CAUTION!
Damage from hard and pointed objects!

Hard and pointed objects can damage the glass ceramic panel of the cooktop!

- ▶ Do not use the surface of the cooktop as a worktop.
- ▶ Do not use hard and pointed objects when working on the cooktop.

CAUTION!
Damage from sugary and salty foods!

Sugary and salty foods and juices can damage the hot cooking zone.

- ▶ Make sure sugary and salty foods or juices do not get onto the cooking zone while it is hot.
- ▶ Remove sugary and salty foods and juices from the hot cooking zone.

CAUTION!
Escaping hot liquids!

Unattended pans can boil over allowing hot liquids to escape.

- ▶ Always keep an eye on pans while cooking.
- ▶ Short cooking sessions must be constantly monitored.

CAUTION!**Damage from objects on the cooktop!**

Objects such as pan lids on the cooktop can damage the glass ceramics.

- ▶ Do not leave objects on the hot cooktop.

**DANGER!****Risk of electric shock!**

If the mains connection cable comes into contact with hot hobs, it could get damaged. A damaged mains connection cable can cause a (deadly) electric shock.

- ▶ Make sure that the mains connection cable cannot come into contact with hot hobs.
- ▶ Make sure that the connection cable is not squashed or damaged.

2.3 Safety instructions – installation

The device must only be installed and assembled by trained specialists who are familiar with and comply with the standard national regulations and supplementary regulations of the local utility companies.

Work on electrical components must be conducted by trained electrical personnel.

The electrical safety of the appliance is only guaranteed if it is connected to a protective conductor system that has been installed in line with regulations. Ensure that this basic safety precaution is met.

Cooktop

**DANGER!****Risk of electric shock!**

Incorrect connection of the device to the mains voltage could cause electric shocks.

- ▶ Make sure that the device is firmly connected to the mains voltage.
- ▶ Make sure the device is connected to a properly installed earth conductor system.
- ▶ Make sure a system is installed which allows disconnection from the network with a contact opening width of at least 3 mm across all poles (circuit breaker, fuses, automatic circuit breakers, contactors).

**CAUTION!****Lifting heavy loads can cause back injuries!**

If not correctly handled, removing and installing the device can cause injuries to the limbs or torso.

- ▶ Removing the cooktop from the packaging is a two-person job.
 - ▶ Placing the cooktop into the worktop cut-out is a two-person job.
 - ▶ Use appropriate aids to prevent damage or injuries to limbs or torso.
-
- ▶ Check the appliance for visible damage before installing it.
 - ▶ Do not install damaged devices.
 - A damaged device is a hazard.
 - Repair work must only be carried out by specialists authorised by the manufacturer.

2.4 Safety instructions – disassembly and disposal

The device must only be disassembled by trained specialists who are familiar with and comply with the standard national regulations and supplementary regulations of the local utility companies.

Work on electrical components must only be conducted by trained electrical personnel.



DANGER!

Risk of electric shock!

Incorrectly disconnecting the appliance from the mains results in a risk of electric shock.

- ▶ Securely disconnect the appliance from the mains using LS switches, fuses, automatic circuit breakers or contactors.
- ▶ Use an authorised measuring device to ensure that there is no power to the appliance.



DANGER!

Risk of asphyxiation!

Packaging components (e.g. film, polystyrene) can be life-threatening for children.

- ▶ Store all packaging components out of reach of children.
- ▶ Dispose of the packaging properly and immediately.

2.5 Safety instructions – spare parts



WARNING!

Risk of injury and damage to property!

Incorrect components can lead to personal injury or damage to the appliance. Modifications, additions or alterations to the appliance can lead to safety risks.

- ▶ Only use original spare parts for repairs.

2.6 Intended use

The device cannot be used at altitudes above 2000 m (metres above sea level).

The device is designed exclusively for the preparation of food in private households. This appliance is not intended for:

- Outdoor use
- Installation in vehicles
- Heating rooms
- Use in non-stationary installation sites (e.g. on ships)
- Use with an external timer or a separate remote control system (remote operation)

Any use other than that specified in these operating and installation instructions or any use that goes beyond that which is described here is classed as unintended. BORA does not assume any liability for damages caused by improper use or incorrect operation.

All misuse is prohibited!

INFO

BORA Holding GmbH, BORA Vertriebs GmbH & Co KG, BORA APAC Pty Ltd and BORA Lüftungstechnik GmbH do not assume any liability for damage arising from non-adherence to the safety and warning information.

3 Technical data

Parameter	Value
Supply voltage	220 - 240 V
Frequency	50/60 Hz
Power consumption	3.7 kW
Fuse protection, minimum	1 x 16 A
Dimensions (width x depth x height)	340 x 515 x 52 mm
Weight (incl. accessories/ packaging)	7.2 kg
Cooktop	
Power levels	1 - 9, P
Front cooking zone power setting	230 x 207 mm 2100 W 3700 W
Back cooking zone power setting	230 x 207 mm 2100 W 3700 W
Cooktop energy consumption	
Front cooking zone	230 x 207 mm 193.0 (Wh/kg)
Back cooking zone	230 x 207 mm 186.9 (Wh/kg)
Cooking zones bridged	230 x 414 mm 204.9 (Wh/kg)
Total (average)	194.9 (Wh/kg)

Tab. 3.1 Technical data

Device dimensions

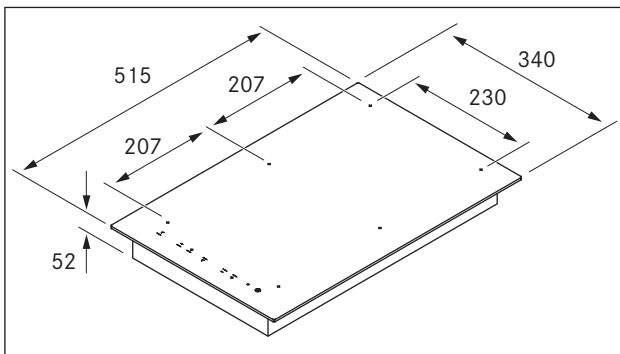

Fig. 3.1 Device dimensions

4 Device description

Observe all safety and warning information during operation (see the Safety chapter).

The cooktop has the following features:

- Automatic heat up function
- Safety shut-down
- Bridging function
- Electronic power control (9 levels)
- Child safety lock
- Pause function
- power setting
- Residual heat display
- Timer functions
- Pan detector
- Heat retention level

4.1 Structure

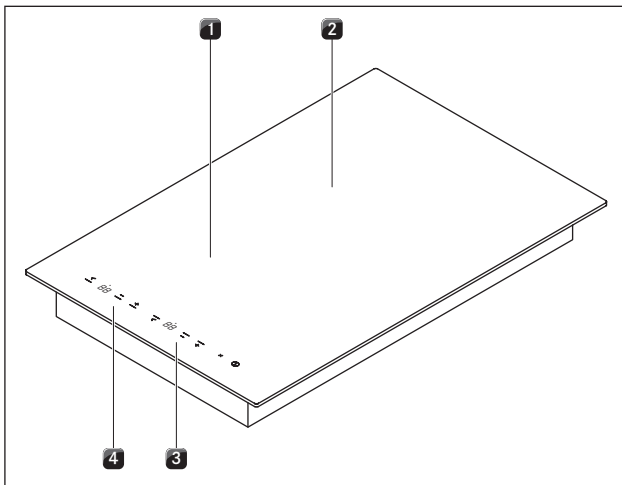

Fig. 4.1 Cooktop

- [1] Front surface induction cooking zone
- [2] Back surface induction cooking zone
- [3] Operating panel for the back cooking zone
- [4] Operating panel for the front cooking zone

4.2 Operating panel and operating principle

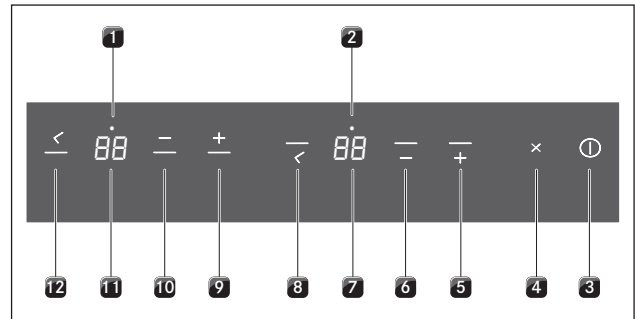

Fig. 4.2 Operating panel

Sensor keys:

[3] switch cooktop on/off

[4] Pause button

Back cooking zone:

[5] increase power level

[6] reduce power level

[2] Indicator light for the activated timer

[7] Cooking zone indicator

[8] Timer button

Front cooking zone:

[9] increase power level

[10] reduce power level

[1] Indicator light for the activated timer

[11] Cooking zone indicator

[12] Timer button

Display panel	Display	Meaning
Cooking zone indicator	1...9	Power level
	P	power setting
	A	Automatic heat up function
	L	Child safety lock active
		Break
	∩	Bridging function (display only on front cooktop display)
	∪	Heat retention level
	∪	No cookware or cookware is too small.
	⌞	Button pressed and held
	H	Residual heat display: Cooking zone is switched off but still hot (temperature > 60°C)
Cooking zone indicator light	On	Automatic cut-off (timer) activated
	Flashes	Timer on (00); no time set
	Off	Timer off
Timer display	01...99	Set minutes for short time (alarm) or automatic cut-off (egg timer)
	00	Timer on; no time set

Tab. 4.1 Meaning of displays

Touch control

The operating panel is fitted with electronic sensor buttons and display panels. The sensor buttons respond to finger contact.

You operate the device by touching the corresponding sensor key with your finger. Keep the finger pressed on the sensor key until you either hear an acoustic signal or the display changes accordingly.

4.3 Functional principle

An induction coil is located underneath an induction cooktop. If the cooking zone is switched on, this coil creates a magnetic field that acts directly on the base of the pot thus heating it up. The cooking zone is only indirectly heated up by the heat emitted by the pot. Cooking zones with induction only work if the cookware has a magnetisable base.

The induction automatically takes into account the size of the used cookware which means that only the area in the cooking zone covered by the base of the pot is heated up.

► Observe the minimum pot base diameter (see the Technical data chapter).

4.3.1 Power levels

The high power output of induction cooktops results in the very quick heating up of cookware. A slight adjustment is needed in comparison to conventional cooking systems when selecting the power level in order to avoid burning food.

Activity	Power level
Keeping cooked food warm at approx. 75°C	␣
Melting of butter and chocolate, breaking up gelatine	1
Keeping sauces and soups warm, soaking rice	1-3
Cooking potatoes, pasta, soups, ragouts, steaming fruit, vegetables and fish, defrosting food	2-6
Frying in coated pans, moderate frying (without overheating the fat) of pork cutlets, fish	6-7
Heating up fat, browning fish, cooking thickened sources and soups, making omelettes	7-8
Cooking large quantities of liquid, browning steaks	9
Heating up water	P

Tab. 4.2 Recommendations for power levels

The specifications provided in the table are standard values. Depending on the cookware and filling quantity, it is recommended to either decrease or increase the power level.

4.3.2 power setting

The two cooking zones are equipped with a power-enhancing power setting.

The power setting can be used in order to quickly heat up large quantities of water. If the power level is activated, the cooking zones will run at extra high power. After 10 minutes, the power level is automatically switched to level 9.

If the bridging function is activated, the power setting cannot be used.

INFO Never heat up oil, fat and the like at this power setting. The bottom of the pan can overheat due to the high power output.

4.3.3 Automatic heat up function

The two cooking zones are equipped with an automatic heat up function that can be switched on and off.

■ The display shows P.

This function enables the cooking zone to work at full power for a certain duration after switching on. After this time, the power level is automatically switched back to the power level set.

Power level	1	2	3	4	5	6	7	8
Cooking duration in min:sec	0:40	1:00	2:00	3:00	4:30	7:00	2:00	3:00

Tab. 4.3 Overview of the automatic heat up function

4.3.4 Heat retention level

The heat retention level keeps cooked foods warm at approx. 75°C.

■ ␣ is displayed in the cooking zone indicator.

■ The maximum duration for the warming function is limited to 2 hours.

4.3.5 Bridging function

The two cooking zones can be operated as a connected cooking zone at the same power level.

■ The display shows P.

The bridging function is suitable for heating food in a roaster.

4.3.6 Pan detector

The cooking zone does not work

■ ␣ appears in the display.

■ If it is switched on without cookware or with unsuitable cookware.

■ If the base diameter of the cookware is too small.

■ If the cookware is removed from a cooking zone that is switched on.

4.3.7 Pause function

The cooking session can be briefly interrupted by pressing the multi-functional button.

- **|||** appears in the display.
- The cooking session and set timer are interrupted while the pause function is active.
- The pause function is limited to a maximum duration of 10 minutes.

4.3.8 Timer functions

You can use 2 timer functions:

- Short-time timer (egg timer), no automatic switching off of a cooking zone.
- Automatic cut-off for automatically switching off a cooking zone.

4.3.9 Suitable cookware

INFO The heating and heat through time for the base of the cookware as well as the cooking results are significantly influenced by the structure and material of the cookware.



Cookware with this symbol is suitable for induction cooktops. The cookware used for the induction cooktop must be made of metal, feature magnetic properties and possess a sufficient bottom surface.

Suitable cookware is made of:

- stainless steel with a magnetisable base
- enamelled steel
- cast iron

Cooking zone	Minimum diameter
Front	120 mm
Back	120 mm

Tab. 4.4 Minimum cookware diameter

- ▶ Perform a magnet test, if necessary. If a magnet sticks to the base of the utensils, they are normally induction compatible.
- ▶ Pay attention to the cookware bottom. The base of the cookware should not show any sign of curvature. Due to incorrect temperature monitoring of the hob caused by the air gap between the cookware and the temperature sensor underneath the hob, overheating may occur. The bottom of the cookware must not have any sharp grooves or sharp edges to avoid scratching the cooktop.
- ▶ Place the cookware (without a mat or similar) directly onto the glass ceramic.

Noises

The following noises may occur in the cookware when using induction cooking zones, depending on the material and the finish of the base:

- **Humming** may occur when using a high power level. It decreases or disappears if the power level is decreased.
- **Crackling or whistling** may occur due to the bases of cookware made of different materials (e.g. sandwich base).
- **Clicking sounds** may occur during electronic switching procedures especially at low power levels.
- **Whirring** may occur when the cooling fan is switched on. In order to increase the service life of the electronic system, the cooktop is equipped with a cooling fan. The cooling fan switches on automatically if the cooktop is used intensively. You will hear a whirring sound. The cooling fan may continue running after the device has been switched off.

4.4 Safety devices

4.4.1 Residual heat display

INFO While **H** is displayed in the cooking zone indicator (residual heat display), do not touch the cooking zone or place any heat-sensitive objects on top of it. Risk of burns and fire!

After switching it off, the cooking zone remains hot. **H** is displayed in the cooking zone indicator (residual heat indicator). The cooking zone indicator will go out after sufficient cooling time (temperature < 60°C).

4.4.2 Safety shut-down of the cooking zone

Each cooking zone is switched off automatically when the cooking zone in the power level exceeds the maximum operating duration. **H** (residual heat display) is then displayed in the cooking zone indicator.

Power level	0	1	2	3	4	5	6
Switch off after hours:minutes	2:00	8:40	6:45	5:15	4:20	3:30	2:45

Power level	7	8	9
Switch off after hours:minutes	2:20	1:45	1:30

Tab. 4.5 Overview of the safety shut-down

- ▶ Switch the cooking zone back on (see Operating control) if you want to put the cooking zone back into operation.

4.4.3 Overheating protection

The device is fitted with overheating protection. The overheating protection can be triggered if:

- Cookware is heated up empty.
- Oil or fat is heated on high power.
- A hot cooking zone is switched on again after a power cut.
- There is insufficient ventilation below the cooktop (see Cooktop air intake).

Before the overheating damages the electronics, one of the following measures is taken:

- The power level can no longer be increased.
- The power level set is reduced.
- The cooktop switches off completely.

After a sufficient cooling period, the cooktop can be used again in full.

4.4.4 Automatic switch-off if the button is pressed and held

The cooktop will be switched off automatically when one or more sensor buttons are touched for longer than 10 seconds (finger contact, objects, soiling).

- The display shows r^{\prime} .
- After a few seconds, the cooktop will switch off.
- ▶ Remove the finger or object from the cooktop.
- ▶ Clean the cooktop as required.
- ▶ Where necessary, switch the cooktop back on.

4.4.5 Child safety lock

The child safety lock prevents the cooktop from being switched on automatically. The child safety lock can only be activated when the cooktop is switched on and all cooking zones have been switched off (see the Operation chapter).

5 Installation

- ▶ Observe all safety and warning information (see the Safety section).
- ▶ Follow the enclosed manufacturer's information.

INFO The device must not be installed above cooling devices, dishwashers, stoves, ovens, washing machines or dryers.

INFO The contact surface of the worktops and wall sealing strips must be made of a heat-resistant material (up to approx. 100°C).

INFO Worktop cut-outs must be moisture-sealed using suitable means or, where necessary, fitted with a thermal insulator.

INFO If the induction glass ceramic wok is used, the groove dimensions must be increased to 7mm for flush installation!

5.1 Checking the scope of delivery

Name	Quantity
Operating and installation instructions	1
Cooktop fixing screws set	1
Sealing tape	1
Cooktop	1
Glass ceramic scraper	1
Height adjustment plate set	1
Mounting straps set for cooktop	1
Glass ceramic cleaning instructions	1

Tab. 5.1 Scope of delivery

- ▶ Check the scope of delivery for damage and make sure it is complete (see Tab. 5.1).
- ▶ If there are any missing or damaged parts, please notify BORA After Sales Service.
- ▶ Do not under any circumstances install parts which are damaged.
- ▶ Dispose of transport packaging in the proper manner (see the Decommissioning and Disposal section).

5.2 Tool and aids

The following tools are required for the correct installation of the cooktop:

- Phillips screwdriver Z2
- Silicone for sealing cutting surfaces

5.3 Assembly instructions

5.3.1 Safety clearances

- ▶ Maintain the following safety clearances:

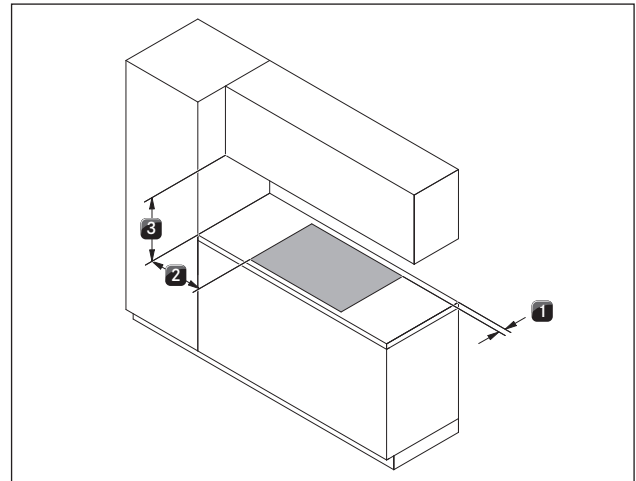

Fig. 5.1 Recommended minimum clearances

- [1] Rear minimum clearance of 50 mm between the worktop cut-out and the rear edge of the worktop.
- [2] Minimum clearance of 300 mm from the left and right of the worktop cut-out to the adjacent cabinet or wall.
- [3] Minimum clearance of 650 mm between the worktop and the wall unit. A minimum clearance of 1,000 mm is recommended for ergonomic reasons.

5.3.2 Work surface and kitchen units

- ▶ Create the worktop cut-out taking the specified cut-out dimensions into account.
- ▶ Make sure that the cutting surfaces of the worktops are properly sealed.
- ▶ Observe the instructions provided by the worktop manufacturer.
- Cross bars on the unit in the area of the worktop cut-out may need to be removed.
- Cable protection (false floor) should be mounted below the appliances. This needs to be removable for maintenance work.
- The drawers and/or shelves in the floor unit must be removable.
- A return flow aperture > 500 cm² is required in the kitchen units for recirculation appliances (e.g. by shortening the plinth boards or using suitable slatted plinths).

5.3.3 Cooktop air intake

The components in the cooktop which generate heat are automatically cooled. The warm air is extracted by fans (cold air flow).

INFO In order to retain the full functionality of the cooktop in the long term, there must be sufficient ventilation underneath the cooktop.

INFO The performance of the cooktop is impaired or the cooktop overheats if the warm air below the cooktop cannot escape.

INFO If the cooktop overheats, performance is reduced or the cooktop switches off completely (see Overheating protection).

INFO For sufficient air intake, an opening cross-section in the kitchen units of at least 50 cm² is recommended.

► Ensure there is sufficient ventilation underneath the cooktop.

INFO The cable protection (false floor) must not prevent sufficient ventilation.

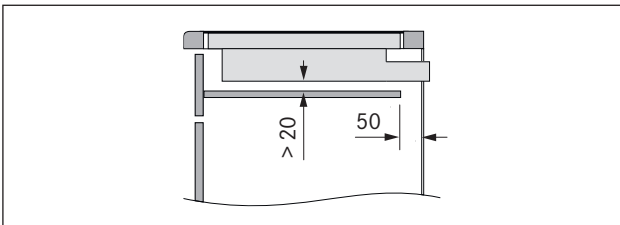

Fig. 5.2 Side view of the cable protection and ventilation

5.4 Cut-out dimensions

INFO All dimensions from the front edge of the front cover.

► Please note the worktop overhang x when creating the worktop cut-out. Applies to flush installation and surface mounting.

Flush installation

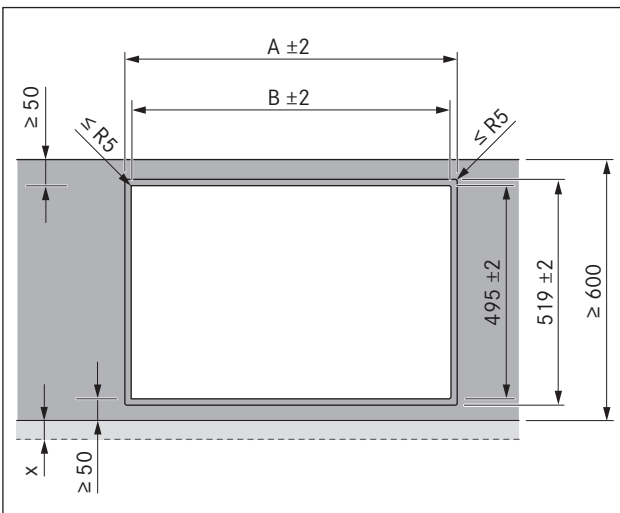

Fig. 5.3 Flush installation

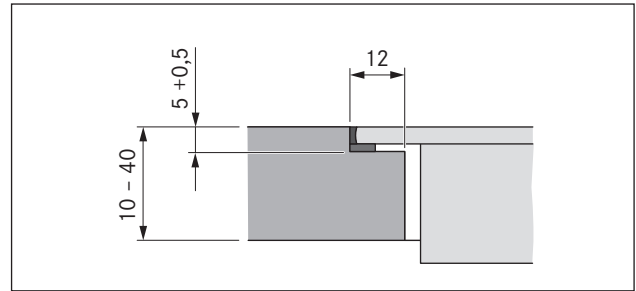







Fig. 5.4 Groove dimensions cut-out

Cut-out dimensions when installing cooktops or cooktops and the BORA cooktop extractor next to each other:

Cooktops/cooktop extractor	A in mm	B in mm	
	1/0	344	320
	2/0	685	661
	3/0	1026	1002
	2/1	776	752
	3/2	1208	1184
	4/2	1549	1525

Tab. 5.2 Cut-out dimensions

Surface mounting

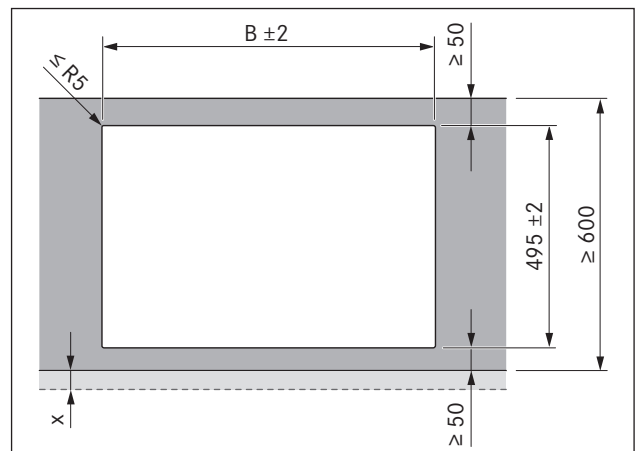

Fig. 5.5 Surface mounting

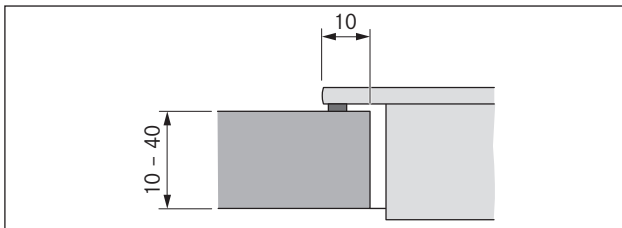



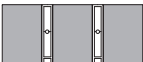



Fig. 5.6 Surface mounting cut-out

Cut-out dimensions when installing cooktops or cooktops and the BORA cooktop extractor next to each other:

Cooktops/cooktop extractor		B in mm
	1/0	320
	2/0	661
	3/0	1002
	2/1	752
	3/2	1184
	4/2	1525

Tab. 5.3 Cut-out dimensions

Attaching the sealing tape

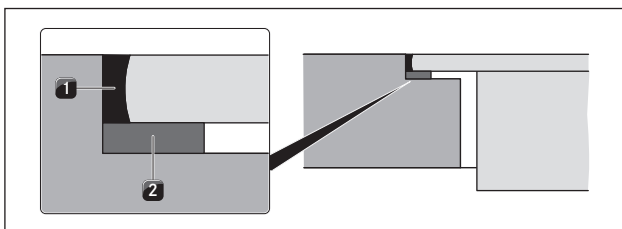

Fig. 5.7 Sealing tape with flush installation

- [1] Black, heat-resistant silicone sealant
[2] Sealing tape

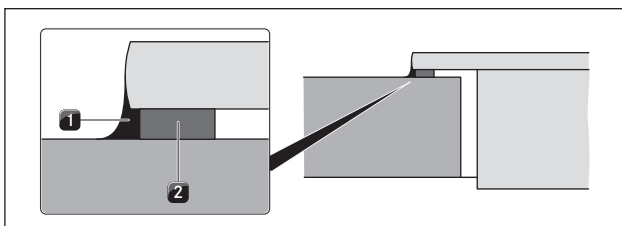

Fig. 5.8 Sealing tape with surface mounting

- [1] Black, heat-resistant silicone sealant
[2] Sealing tape

■ No sealing tape is required on the side of the appliance adjacent to the extraction system as the extraction frame can otherwise be damaged.

- ▶ With surface mounting, attach the enclosed sealing tape [2] to the underside of the device before installing it. Do not leave any gaps with the exception of the side adjacent to the extraction system.
- ▶ With flush installation, attach the enclosed sealing tape to the horizontal cutting edge in the worktop cut-out, even if you seal the device with a silicone sealant [1] or similar.
- ▶ Note down the type designation and build number of the device (FD number) on the back of this manual. Both details can be found on the nameplate on the underside of the device.

5.5 Installing the cooktop

INFO Clearance of one millimetre should be planned between the built-in appliances.

INFO A clearance of two millimetres should be planned around the built-in appliances.

Installing the cooktop

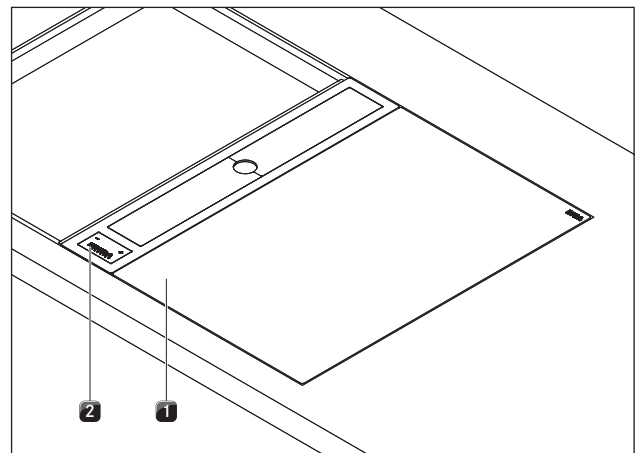

Fig. 5.9 Installed cooktop with cooktop extractor

- [1] Cooktop
[2] Cooktop extractor

- ▶ Insert the cooktop [1] next to the cooktop extractor [2] that has already been installed in the centre.

INFO The cooktop [1] lies on the side rail of the cooktop extractor [2], which stabilises it.

- ▶ Precisely position the cooktop [1].
- ▶ If necessary, use the height adjustment plates to adjust the cooktop's installation height.

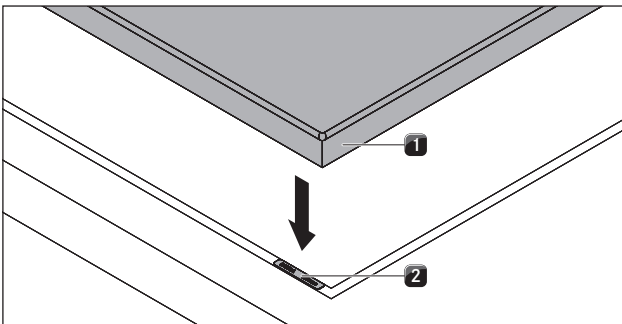

Fig. 5.10 Cooktop and height adjustment plates

- [1] Cooktop
[2] Height adjustment plates

For surface mounting

- ▶ Make sure that the sealing tape for the cooktop is flat against the worktop.

For flush installation

- ▶ Make sure that the sealing tape of the cooktop is sealed well all the way round.

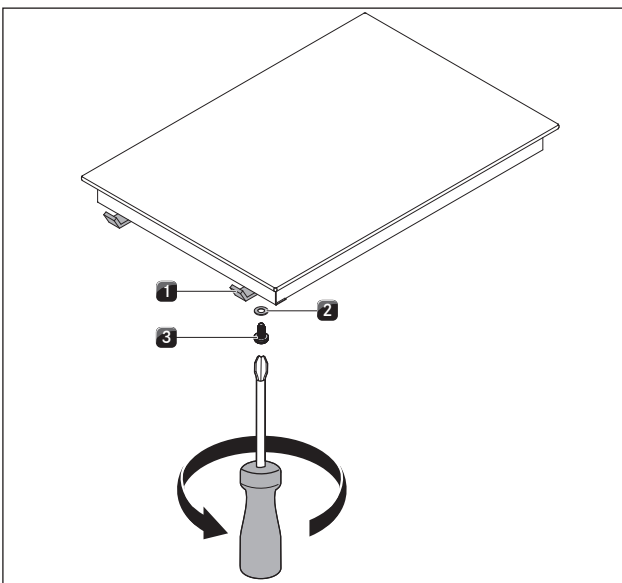

Fig. 5.11 Mounting brackets

- [1] Mounting bracket
[2] Washer
[3] Screw

- ▶ Affix the cooktop using the mounting brackets [1].
- ▶ Use the screw [3] and the washer [2] to tighten the mounting brackets with max. 10 Nm.
- ▶ Check that the cooktop is positioned correctly.
- ▶ Once all of the installation work is complete, seal the devices with black, heat-resistant silicone sealant.

5.6 Power connection

- ▶ Observe all safety and warning information in the Safety section.
- ▶ Observe all national and regional laws and regulations as well as the supplementary regulations of the local utility companies.

INFO The power connection may only be established by a certified specialist. He/she also assumes responsibility for the proper installation and commissioning.

The power supply line for use (pre-assembled) must be of the type H05VV-F or H05VVH2-F as a minimum.

- Cross-section: 3G 1.5 mm²
- If the connection line has been damaged this must be replaced by a special connection line. This may only be done by an authorised member of the After Sales Service team.

Establishing the power connection

- ▶ Switch off the main switch/automatic circuit breaker before connecting the cooktop.
- ▶ Secure the main switch/automatic circuit breaker against being switched back on without permission.
- ▶ Make sure the power to the appliance is disconnected.
- ▶ Connect the mains cable.
- ▶ Only connect the cooktop using a permanent connection to a power supply cable.

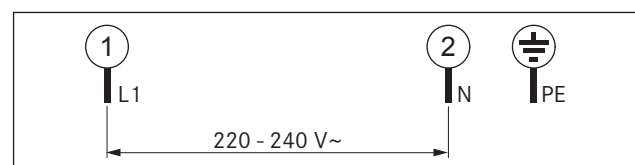

Fig. 5.12 Connection diagram 1-phase

- ▶ Check that the cooktop has been correctly installed.
- ▶ Switch on the main switch/automatic circuit breaker.
- ▶ Put the cooktop into operation (see the Operation section).
- ▶ Check that all the functions are working correctly.

5.7 Handover to user

Once installation is complete:

- ▶ Explain the main functions to the user.
- ▶ Explain all safety-related aspects of operation and handling to the user.
- ▶ Provide the user with the accessories and operating and installation instructions for safe storage.

6 Operation

- ▶ Observe all safety and warning information during operation (see the Safety chapter).

INFO The cooktop may only be operated when the stainless steel grease filter of the cooktop extractor is installed (see operating instructions for cooktop extractor).

INFO Clean the cooking zone before using the cooktop for the first time (see the Cleaning chapter).

6.1 Switching cooktop on/off

Switching on

- ▶ Press **ⓘ** to switch on the cooktop. The power level **5** is displayed in the cooking zone indicators.
- If no power level is set after switching on the appliance, the cooktop will turn off after a few seconds.

Switching off

INFO Use the operating panel to switch off the cooking zone after use. Do not rely on the pan detector.

- ▶ Press **ⓘ** to switch off the cooktop.
- ▶ Pay attention to the residual heat display (see the Device Description chapter).

6.1.1 Switching on the cooking zone

- ▶ Press the **+** button for the desired cooking zone. The **5** in the cooking zone indicator lights up more brightly. The cooking zone indicator light illuminates.

6.1.2 Adjusting the power level

- ▶ Press **+** to set power level **5** **-** to set power level **9**.

6.1.3 Changing the power level

- ▶ Press **+** or **-** until the required power level is shown in the cooking zone indicator.

6.1.4 Switching on the power setting

INFO Both cooking zones are equipped with a power-enhancing power setting.

If a cooking zone is operated at power setting **P**, the other cooking zones can be operated at a maximum power level of **5**.

If the power setting is increased to **5**, the power level will switch back to **P**.

- ▶ Continue pressing **+** until power setting **P** is displayed in the cooking zone indicator.

- After 10 minutes, the cooking zone is automatically switched back to power level **9**.

6.1.5 Switching the power setting off early

- ▶ Continue pressing **-** until the lower power level that you want is displayed.

6.1.6 Switching off the cooking zone

INFO If a cooking zone indicator shows **H**, the cooking zone is still hot.

- ▶ Continue pressing **+** or **-** until the cooking zone indicator displays power level **5**. The display will show a **5** for a few seconds.

- ▶ Press **+** and **-** simultaneously.

6.1.7 Pause function

INFO The pause function switches off automatically after 10 minutes.

- ▶ Press the pause button **⊗** on the cooktop to briefly interrupt the cooking session.

- **||** is displayed in the cooking zone indicator.

- ▶ Press the pause button **⊗** again followed by **+** or **-** to end the pause function.

By pressing the **ⓘ** button when the pause function is active, the previous setting can be activated again within 6 seconds.

To do so, press the **ⓘ** button and then **⊗**.

6.1.8 Bridging function

- If the bridging function is active, both cooking zones will operate at the same time on the same cooking zone.

Switching on the bridging function

Prerequisite

- ▶ Press **⏻** to switch on the cooktop.
- ▶ Press both the **+** buttons on the cooktop (within 10 seconds).
- The left cooking zone indicator will show the symbol **⏻**, indicating that the bridging function is activated. **⏻** is displayed in the right cooking zone indicator.
- ▶ Set the desired power level with the **+** or **-** button on the back cooking zone.

Switching off the bridging function

- ▶ Press both **+** buttons on the cooktop.
- Both cooking zone indicators will display **⏻**.
- ▶ Press **⏻** to switch off the cooktop.

6.1.9 Automatic heat up function

Switching on the automatic heat up function

Prerequisite

- The cooktop is switched on.
- All cooking zones are switched off.
- ▶ Press the **+** and **-** buttons on the cooktop.
- ▶ Press the **-** button (within 5 seconds) to select the desired power level (continuous cooking stage), which should be used to continue the cooking session after the end of the automatic heat up function.
- The cooking zone indicator will display the symbol **⏻** to show that the automatic heat up function is activated as well as the continuous cooking stage set, for example **5**.

Switching off the automatic heat up function

The activated automatic heat up function will end prematurely if you

- ▶ press the **-** button on the cooking zone.
- ▶ set power level **9**.
- ▶ activate the power setting **P**.
- ▶ activate the heat retention level **⏻**.
- ▶ switch off the cooktop by pressing the **⏻** button.

6.1.10 Heat retention level

- A cooking zone is in use.
- Power level **1** is activated.
- ▶ Press **-** to set the heat retention level **⏻**.
- The cooking zone will automatically switch off after 2 seconds.

6.1.11 Using the timer function

You can use 2 timer functions:

- Short-time timer (egg timer), no automatic switching off of a cooking zone.
- Automatic cut-off for automatically switching off a cooking zone.

You can set a time range of between 1 and 99 minutes for both timer functions.

- ▶ If you press **+** first, 1 minute will be pre-set as the starting time.
- ▶ If you press **-** first, 30 minutes will be pre-set as the starting time.

Switching off the timer signal tone

- ▶ Press any sensor button on the operating panel to end the signal tone prematurely.

Setting the short-time timer (egg timer)

You can set a short-time timer for each cooking zone.

INFO	The active cooking zone indicator shows that the short-time timer is activated. The remaining time is displayed.
-------------	---

After the end of the time set, 00 will be displayed for a few seconds on the timer display. A signal tone will sound for a few seconds.

Prerequisite

- The cooktop must be switched on.
- ▶ Press the timer button **⏻** or **⏻**.
- Each indicator light will blink and **⏻** will appear in the cooking zone indicator.
- ▶ Press **+** or **-** to set the required time.
- Activation will take place within 10 seconds of the button last being pressed.
- If the cooktop is switched off with the on/off button **⏻**, the cooking zone indicator will become active and the remaining time will be displayed.

Changing the timer settings

- ▶ Press **⏻** to switch on the cooktop.
- The timer indicator light blinks.
- ▶ Press **+** or **-** to set the required time.





Setting the automatic cut-off

You can set an automatic cut-off for every cooking zone.



INFO The active cooking zone indicator shows that the automatic cut-off is activated. The remaining time is displayed.

After the end of the time set, the cooking zone turns off automatically.







Prerequisite

- A cooking zone has been selected.
- A power level was set.
- ▶ Press the timer button .
- The relevant cooking zone blinks and  appears in the cooking zone indicator.
- ▶ Press  or  to set the required time.
- ▶ Press the timer button  again to activate it.
- Activation will take place within 10 seconds of the button last being pressed.

Changing the timer settings

- ▶ Press the timer button  for the cooking zone for which you want to change the time.
- The relevant indicator light blinks.
- ▶ Press  or  to set the required time.

Switching the timer off early



- ▶ Press the timer button  for the cooking zone for which you want to switch off the timer.
 - The relevant indicator light blinks.
 - ▶ Press  until the timer display shows ,
- or
- ▶ press  and  simultaneously. The time in the timer display is immediately set to .

6.1.12 Activating/deactivating the childproofing feature

INFO If a cooking zone indicator alternates between displaying *L* and *H*, the cooking zone is still hot.

Activating the child safety lock

Prerequisites:



- The cooktop is switched on.
- All cooking zones are switched off.
- ▶ Press the sensor buttons  for the front cooking zone and  for the back cooking zone at the same time. Then press the sensor button  for the front cooking zone again.
- Both cooking zone indicators will display *L*. The child safety lock is activated.

Deactivating the child safety lock for a cooking session

Prerequisites:

- The cooktop is switched on.

INFO If a cooking zone indicator alternately shows  and *H*, the cooking zone is still hot.

- ▶ Press the sensor buttons  for the front cooking zone and  for the back cooking zone at the same time.
- All cooking zone indicators show the power level . The child safety lock is deactivated.



The power level you require can now be set for each cooking zone.

After the cooktop has been switched off, the child safety lock is activated again.

Deactivating the child safety lock

INFO If a cooking zone indicator alternately shows  and *H*, the cooking zone is still hot.

Prerequisites:

- The cooktop is switched on.
- ▶ Press the sensor buttons  for the front cooking zone and  for the back cooking zone at the same time. Then press the sensor button for the  back cooking zone again.
- The child safety lock is deactivated.

7 Cleaning and Maintenance

- ▶ Observe all safety and warning information (see the Safety chapter).
- ▶ Follow the enclosed manufacturer's information.
- ▶ Make sure that the cooktop and cooktop extractor have been switched off completely and have cooled down prior to the planned cleaning and maintenance work to prevent injury (see the Operation chapter).
- Regular cleaning ensures the longevity of the product and optimal functioning.
- ▶ Adhere to the following cleaning and maintenance cycles:

Component	Cleaning cycle
Control panel	immediately after every soiling
Cooktop	immediately after every soiling every week thoroughly with standard commercially available cleaning agents

Tab. 7.1 Cleaning cycles

7.1 Cleaning agents

INFO Due to the use of aggressive cleaning agents and abrasion caused by the pot bases the surface will become damaged and dark stains will occur.

You need a special glass ceramic scraper and suitable cleaning agents to clean the cooktop.

- ▶ Never use steam cleaners, abrasive sponges, scouring pads, or chemically aggressive cleaning agents (e.g. baking oven spray).
- ▶ Make sure that the cleaning agent does not contain any sand, soda, acids or chloride.

7.2 Maintaining the cooktop

- ▶ Do not use the cooktop as a worktop or shelf.
- ▶ Do not push or pull cookware across the cooktop.
- ▶ Always lift pots and pans.
- ▶ Keep the cooktop clean.
- ▶ Remove any kind of soiling immediately.
- ▶ Only use cookware which is suitable for glass ceramic cooktops (see the Device description chapter).

7.3 Cleaning the cooktop

INFO When the cooktop extractor is switched on, the stainless steel grease filter must be installed to ensure that no small and light objects, such as cleaning wipes made of fabrics or paper are sucked in (see operating instructions for the cooktop).

- ▶ Make sure that the cooktop is switched off (see the Operating chapter).
- ▶ Wait until all cooking zones are cold.
- ▶ Remove all coarse soiling and food residues from the cooktop with a glass ceramic scraper.
- ▶ Apply the cleaning agent onto the cold cooktop.
- ▶ Rub the cleaning agent with a paper towel or a clean cloth.
- ▶ Wipe off the cooktop while wet.
- ▶ Rub the cooktop dry with a clean cloth.

When the cooktop is hot:

- ▶ Immediately remove molten residues of plastic, aluminium film, sugar or foods containing sugar with a glass ceramic scraper from the hot cooking zone to prevent burning them in.

Heavy soiling

- ▶ Remove heavy soiling and stains (limescale stains, pearly shimmering stains) with cleaning agents while the cooktop is still warm.
- ▶ Soften dried dirt residues using a damp cloth.
- ▶ Remove dirt residues with the glass ceramic scraper.
- ▶ Always remove grains, crumbs or similar which fall onto the cooktop during general cooking work right away to prevent the surface from being scratched.

Coloured changes and shiny surfaces are not cooktop damage. They do not impact on the function of the cooktop and the stability of the glass ceramic. Discolourations to the cooktop arise from residues which are not removed and have been burnt in. Glossy spots are caused by the abrasion of the pot base, especially when using cooking utensils with aluminium bases, or by unsuitable cleaning agents. They are very hard to remove.

8 Troubleshooting

Observe all safety and warning information (see the Safety chapter).

Operating situation	Cause	Remedy
The cooktop cannot be switched on.	The fuse or the automatic circuit breaker of the electrical installation of the apartment and/or house is defective.	Replace the fuse. Switch the safety cut-out back on.
	The fuse or the automatic circuit breaker trips several times.	Call the BORA Service Team.
	The power supply is disconnected.	Have a specialist electrician inspect the power supply.
Odours and vapours arise when the new cooktop is put into operation.	This is normal on brand-new appliances.	Wait a few operating hours. Contact the BORA Service Team if the odour persists.
\underline{u} is displayed in the cooking zone indicator.	No or unsuitable cookware has been placed on the cooking zone.	Only use suitable cookware. Select the cookware size depending on the cooking zone (see the Device Description chapter).
\underline{L} is displayed in the cooking zone indicator.	The child safety lock is activated.	Switch off the childproofing feature (see the Operation chapter).
\underline{r} is displayed in the cooking zone indicator.	Press and hold one or more buttons.	Clean the operating panel or remove objects (see the Device description chapter).
\underline{E} is displayed in the cooking zone indicator.	The associated cooking zone or a power element is defective.	Note down the error number and contact the BORA Service Team.
A cooking zone or the entire cooktop switches off automatically.	The operating time of a cooking zone has been exceeded.	Put the cooking zone back into operation (see the Operation chapter).
	The overheat protection has tripped.	(see the Device Description chapter)
The power setting is automatically shut off prematurely.	The overheat protection has tripped.	(see the Device Description chapter)
The cooling fan continues running after the cooktop has been switched off.	The fan will continue to run until the cooktop has cooled down and will then switch off automatically.	Wait until the cooling fan switches off automatically.

Tab. 8.1 Resolving a fault

► In all other instances, call the BORA Service Team (see the Warranty, service and spare parts chapter).

9 Decommissioning, disassembly and disposal

- ▶ Observe all safety and warning information (see the Safety section).
- ▶ Follow the enclosed manufacturer's information.

9.1 Decommissioning

Decommissioning is understood as final shutdown and disassembly. Following decommissioning, the device can either be installed into other units, sold on privately or disposed of.

INFO Electricity and gas connections may only be disconnected by qualified specialists.

- ▶ To decommission, switch the device off (see Operation section)
- ▶ Disconnect the device from the power supply.

9.2 Disassembly

For removal, the device must be accessible for disassembly and disconnected from the power supply. For gas devices, make sure the gas connection is disconnected.

- ▶ Undo the mounting brackets.
- ▶ Remove the silicone joints.
- ▶ Remove the device from the worktop by lifting it upwards.
- ▶ Remove any other accessories.
- ▶ Dispose of the old device and any contaminated accessories as described under "Environmentally-friendly disposal".

9.3 Environmentally-friendly disposal

Disposal of transport packaging

INFO The packaging protects the device from damage in transport. The packaging materials have been selected from environmental and disposal perspectives and are therefore recyclable.

Returning the packaging to the materials cycle saves resources and reduces waste volumes. Your specialist supplier will take the packaging back.

- ▶ Give the packaging to your specialist supplier or
- ▶ Dispose of the packaging properly in line with local regulations.

Disposal of old appliance



Electrical devices marked with this label may not be disposed of in domestic waste at the end of their service life. They must be disposed of at a collection point for the recycling of old electrical or electronic devices. You can find information from your city or district council.

Many electrical and electronic devices still contain valuable materials. But they also contain damaging materials which were necessary for them to function properly and safely. These can damage human health or the environment if disposed of improperly or incorrectly handled.

- ▶ Never put your old appliance in domestic waste.
- ▶ Take the old appliance to a regional collection point for return and recycling electrical and electronic components and other materials.

10 Warranty, technical service, spare parts

- ▶ Observe all safety and warning information (see the Safety section).

10.1 Warranty

The warranty period is 2 years.

10.2 Service

BORA Service:

see back page of operation and installation instructions



- ▶ If there are faults which you are not able to resolve yourself, please contact your BORA specialist supplier or the BORA Service Team.

The BORA Service Team requires the type designation and the build number of your appliance (FD number). Both pieces of information can be found on the nameplate on the back of the instructions and on the appliance base.

10.3 Replacement parts

- ▶ Only use original spare parts for repairs.
- ▶ Repairs may only be carried out by the BORA Service Team.

INFO Replacement parts can be obtained from your BORA dealer, the BORA online service website at www.bora.com/service or by calling the service number provided.

Nameplate:
(please affix)

Germany:

BORA Lüftungstechnik GmbH
Rosenheimer Str. 33
83064 Raubling
Germany
T +49 (0) 8035 / 9840-0
F +49 (0) 8035 / 9840-300
info@bora.com
www.bora.com

Australia - New Zealand:

BORA APAC Pty Ltd
100 Victoria Road
Drummoyne NSW 2047
Australia
T +61 2 9719 2350
F +61 2 8076 3514
info@boraapac.com.au
www.bora-australia.com.au

Austria:

BORA Vertriebs GmbH & Co KG
Innstraße 1
6342 Niederndorf
Austria
T +43 (0) 5373 / 62250-0
F +43 (0) 5373 / 62250-90
mail@bora.com
www.bora.com

Europe:

BORA Holding GmbH
Innstraße 1
6342 Niederndorf
Austria
T +43 (0) 5373 / 62250-0
F +43 (0) 5373 / 62250-90
mail@bora.com
www.bora.com

