

EN

Operating and installation instructions M Pure

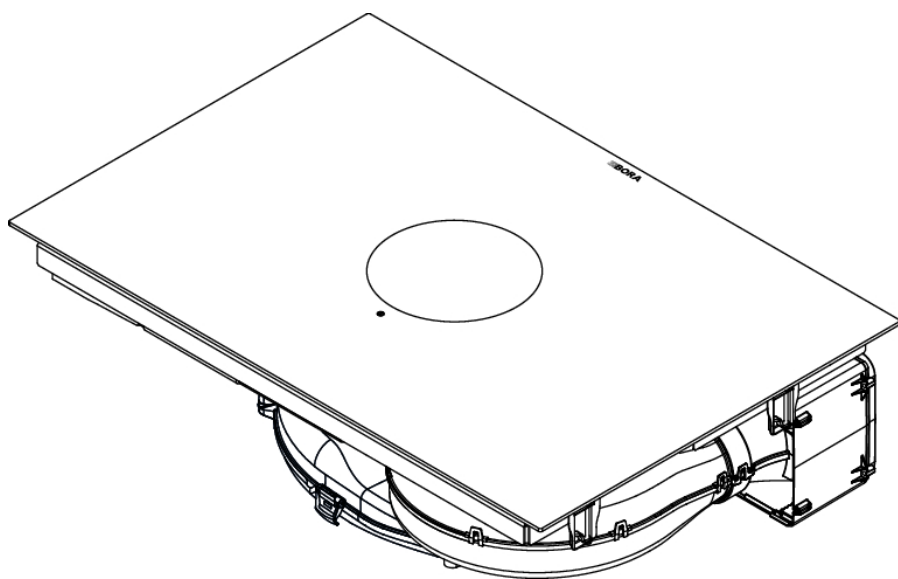

Contents

1	General information	72	5.2	Touch control	93
1.1	Validity of the operating and installation instructions	72	5.3	Function overview	93
1.2	Installation	72	5.4	Operating the system	93
1.3	Product conformity	72	5.4.1	Switch on/off.....	93
1.4	Presentation of information.....	72	5.4.2	Short-time timer.....	94
1.4.1	Safety and warning instructions.....	72	5.5	Cooktop extractor functions	94
1.4.2	Figures	73	5.5.1	Setting the fan power levels.....	94
2	Safety	74	5.5.2	Fan power setting	94
2.1	Intended use.....	74	5.5.3	Automatic extractor function	94
2.2	People with limited abilities.....	74	5.5.4	Switching the fan off.....	95
2.3	General safety instructions.....	75	5.5.5	Automatic after-run.....	95
2.4	Safety information for installation.....	77	5.5.6	Filter service display	95
2.4.1	Safety instructions – cooktop extractor installation	78	5.6	Cooktop functions	95
2.4.2	Safety information for cooktop installation	79	5.6.1	Pan size recognition.....	95
2.5	Safety instructions – operation	80	5.6.2	Selecting a cooking zone	95
2.5.1	Safety instructions – cooktop extractor operation	81	5.6.3	Setting cooking zone power levels.....	95
2.5.2	Safety instructions – cooktop operation.....	82	5.6.4	Cooking zone power setting.....	96
2.6	Safety instructions – cleaning and maintenance	84	5.6.5	Automatic heat up function.....	96
2.6.1	Safety instructions – cleaning and maintenance of cooktop extractors	84	5.6.6	Cooking zone timer.....	96
2.6.2	Safety instructions – cleaning and maintenance of cooktops.....	85	5.6.7	Pause function	97
2.7	Safety instructions – repairs, servicing and spare parts	85	5.6.8	Heat retention function	97
2.8	Safety instructions – disassembly and disposal	86	5.6.9	Bridging function.....	97
3	Technical data	87	5.6.10	Automatic bridging function	97
3.1	M Pure.....	87	5.6.11	Switching off the cooking zone	98
3.1.1	PURMA appliance dimensions.....	87	5.7	Safety features	98
3.1.2	PURMU appliance dimensions	88	5.7.1	Child lock	98
4	Appliance description	89	5.7.2	Operating lock.....	98
4.1	Model description.....	89	5.7.3	Cleaning lock	98
4.2	System description	89	5.7.4	Residual heat indicator.....	98
4.2.1	Structure.....	89	5.7.5	Safety shut-down	98
4.2.2	Operating panel.....	89	5.7.6	Overheating protection	99
4.2.3	Symbols	90	6	User menu	100
4.2.4	7-segment display.....	90	6.1	Menu item 1: volume of the acoustic signals	100
4.2.5	Lighting.....	91	6.2	Menu item 2: Child lock	100
4.2.6	Sounds.....	91	6.3	Menu item 3: Show filter status and reset filter service display.....	101
4.3	How the cooktop extractor works.....	91	6.4	Menu item 4: Duration of the automatic after-run function.....	101
4.4	How the induction cooktop works	91	6.5	Menu item 5: Touch zone reaction speed	101
5	Functions and operation	93	6.6	Menu item 6: LED test.....	102
5.1	General operating instructions.....	93	6.7	Menu item 7: Permanent pan size recognition	102
			6.8	Menu item 8: Show software/hardware version....	102
			6.9	Menu item 9: Safety shut-down.....	102
			6.10	Menu item A: Super simple mode....	103
			6.11	Menu item 0: Reset to factory settings.....	103

7	Cleaning and maintenance	104		
7.1	Cleaning agents	104	9.7.10	Securing the cooktop
7.2	Cooktop and extractor care	104	9.7.11	Making a connection with the back panel in installation variant A....
7.3	Cleaning the cooktop	104	9.7.12	Inserting the activated charcoal filter
7.4	Cleaning the cooktop extractor	105	9.8	Connecting the power supply
7.4.1	Cleaning the air inlet nozzle and stainless steel grease filter	105	9.9	Initial operation
7.4.2	Removing liquids from the appliance	105	9.9.1	Dealer and service menu
7.5	Cleaning the air guiding housing	106	9.9.2	Menu item B: Extraction system configuration
7.6	Replace the activated charcoal filter	106	9.9.3	Menu item C: Power management
8	Troubleshooting	109	9.9.4	Menu item D: Demo mode
9	Installation	110	9.9.5	Function test
9.1	General installation instructions	110	9.10	Sealing the appliance
9.1.1	Simultaneous operation of the cooktop extractor in the exhaust air mode with a fireplace dependent upon the air supply in the room	110	9.11	Handover to user
9.2	Scope of delivery	111	10	Decommissioning, disassembly and disposal
9.3	Tools and aids	111	10.1	Decommissioning
9.4	Assembly instructions	111	10.2	Disassembly
9.4.1	Installation clearances	111	10.3	Environmentally-friendly disposal ...
9.4.2	Minimum unit dimensions	111	10.3.1	Disposal of transport packaging
9.4.3	Information on kitchen units	111	10.3.2	Disposal of accessories
9.5	Worktop cut-out	112	10.3.3	Disposal of the old appliance
9.5.1	Cut-out dimensions	112	11	Warranty, technical service, spare parts, accessories
9.6	Installing the appliance in exhaust air mode	112	11.1	BORA manufacturer's warranty
9.6.1	Preparing kitchen units for the exhaust air model	113	11.1.1	Warranty extension
9.6.2	Installation dimensions	113	11.2	Service
9.6.3	Preparing the appliance	113	11.3	Spare parts
9.6.4	Inserting the cooktop	114	11.4	Accessories
9.6.5	Securing the cooktop	114	12	Product data sheets
9.6.6	Connecting the appliance to the duct system	114	12.1	PURMA - Cooktop extractor product data sheet
9.7	Installing the appliance in recirculation mode	115	12.2	M Pure - Cooktop product data sheet
9.7.1	Recirculation of air from the kitchen unit	115		
9.7.2	Installation variants (A and B) for recirculation appliances	115		
9.7.3	Preparing the kitchen unit for installation variant A	116		
9.7.4	Installation dimensions for installation variant A	116		
9.7.5	Preparing the kitchen unit for installation variant B	116		
9.7.6	Installation dimensions for installation variant B	117		
9.7.7	Preparing the appliance	117		
9.7.8	Extending the telescopic pull-out of the air purification box	117		
9.7.9	Inserting the cooktop - recirculation	118		

1 General information

These instructions contain important information to protect you from injury and prevent damage to the appliance. Please read these instructions carefully before installing or using the appliance for the first time. Other documents apply alongside these instructions. Please by all means adhere to all documents that form part of the scope of delivery.

Assembly, installation and commissioning must always occur in line with national laws, regulations and standards. The work must be performed by qualified specialists who know and comply with the additional regulations of the local energy supply companies. All safety and warning information as well as the handling instructions in the accompanying documents must be observed.

Please keep these instructions in a safe place and pass them on to the next owner where applicable.

1.1 Validity of the operating and installation instructions

These instructions apply to several appliance versions. It is therefore possible that some of the features described do not apply to your appliance. The details of the figures contained herein may differ from some appliance versions and are to be understood as schematic diagrams.

1.2 Liability

. BORA Holding GmbH, BORA Vertriebs GmbH & Co KG, BORA APAC Pty Ltd and BORA Lüftungstechnik GmbH – hereinafter referred to as BORA – do not assume any liability for damage arising from disregard for or non-adherence to the documents included in the scope of delivery!

Furthermore, BORA shall not be held liable for damage caused by improper installation or failure to observe the safety and warning information!

1.3 Product conformity

Directives

The appliances meet the following EU/EC directives:

- 2014/30/EU EMC Directive
- 2014/35/EU Low Voltage Directive
- 2009/125/EC Ecodesign Directive
- 2011/65/EU RoHS Directive

1.4 Presentation of information

We use standard formatting, numbering, symbols, safety instructions, terms and abbreviations so that you can work quickly and safely when using this manual. The article described in these instructions is hereinafter also referred to as an appliance.

Instructions are indicated with an arrow.

► Always follow all instructions in the prescribed order. Enumerations are indicated with a bullet point at the start of the line:

- Enumeration 1
- Enumeration 2

i Information notes point to special features that must be taken into account.

1.4.1 Safety and warning instructions

The safety and warning instructions in this manual are emphasised with symbols and signal words. Safety and warning instructions are structured as follows:

DANGER

Type and source of danger

Results of non-compliance

► Measures to minimise risk

Please note:

- warning symbols draw attention to a high risk of injury.
- The signal word indicates the severity of that risk.

Warning symbol	Signal word	Risk
	Danger	Indicates an immediate, hazardous situation which causes death or serious injury if not respected.
	Warning	Indicates a potentially hazardous situation which can cause death or serious injury if not respected.
	Caution	Indicates a potentially hazardous situation which can cause death or serious injury if not respected.
	Note	Indicates a potentially hazardous situation which can cause property damage if not respected.

Tab. 1.1 Meaning of the warning symbols and signal words

1.4.2 Figures

All measurements are provided in millimetres.

2 Safety

The appliance complies with the stipulated safety requirements. The user is responsible for the safe use of the appliance, cleaning and maintenance. Improper use can lead to personal injury and damage to property.

2.1 Intended use

The appliance is solely intended for preparing food in private households.

This appliance is not intended for:

- outdoor use
- heating rooms
- cooling, ventilating or dehumidifying rooms
- use in mobile installation sites such as motor vehicles, ships or aeroplanes
- use with an external timer or a separate remote control system
- use at altitudes of over 2000 m (metres above sea level)
- use when not fully installed

Any other use or any use that goes beyond that which is described here is classed as unintended.

i BORA does not assume any liability for damages caused by incorrect installation, improper use or incorrect operation.

All misuse is prohibited!

2.2 People with limited abilities

Children

The appliance can be used by children aged 8 and over if they are supervised or have been instructed how to use the appliance safely and understand the resultant risks. Children must not play with the appliance.

- ▶ Use the childproofing feature in order to prevent children from switching on the appliance or changing the settings when they are unattended.
- ▶ Supervise children in the vicinity of the appliance.
- ▶ Do not store any items that could be of interest to children in storage spaces above or behind the appliance. Otherwise, they will be tempted to climb onto the appliance.

i Any work involving cleaning and maintenance must not be carried out by children unless they are supervised at all times while doing so.

People with reduced physical, sensory or mental capacities

The appliance can be used by people with reduced physical, sensory or mental capacities or a lack of experience and/or knowledge if they are supervised or have been instructed how to use the appliance safely and understand the resultant risks. Operation can be restricted using the child lock.

 DANGER**Risk of burns from hot cookware and food**

Handles projecting over the edge of the worktop are asking to be grabbed.

- ▶ Keep children away from hot cooking zones or ensure they are supervised at all times.
- ▶ Do not turn pot and pan handles so they stick out beyond the work surface.
- ▶ Make sure that hot pots and pans cannot be pulled down.
- ▶ If necessary, use suitable stove guards or covers.
- ▶ Only use stove guards and covers that are approved by the appliance manufacturer; otherwise, there is a risk of accidents.
- ▶ To choose a suitable stove guard, contact your specialist retailer or the BORA Service Team.

2.3 General safety instructions** DANGER****Packaging components are a choking hazard**

Packaging components (e.g. film, polystyrene) can be life-threatening for children.

- ▶ Store all packaging components out of reach of children.
- ▶ Dispose of the packaging properly and immediately.

 DANGER**Risk of electric shock or injury from damaged surfaces**

The underlying electronics can be exposed or damaged due to fissures, fractures or cracks in appliance surfaces (e.g. damaged glass), particularly in the vicinity of the operating unit. This can cause an electrical shock. Furthermore, a damaged surface can cause injuries.

- ▶ Do not touch the damaged surface.
- ▶ If there are any cracks, fissures or fractures, switch the appliance off immediately.
- ▶ Securely disconnect the appliance from the mains using the circuit breaker, fuses, automatic circuit breakers or contactor.
- ▶ Contact the BORA Service Team.

 WARNING**Risk of injury or damage due to incorrect components or unauthorised modifications**

Incorrect components can lead to personal injury or damage to the appliance. Modifications, additions or alterations to the appliance can lead to safety risks.

- ▶ Only use original components.
- ▶ Do not make any modifications, additions or alterations to the appliance.

⚠ WARNING**Risk of injury due to mechanical damage on the appliance**

Mechanical damage (e.g. cracks, deformation, separation of adhesive seals, etc.) to the appliance, as well as to cables and accessories can cause injuries.

- ▶ Do not operate the appliance.
- ▶ Do not try to repair or replace damaged components yourself.
- ▶ Contact the BORA Service Team.

CAUTION**Appliance components can cause injury if dropped**

Appliance components can cause injury if you drop them.

- ▶ Place any appliance components that have been removed in a safe place near the appliances.
- ▶ Ensure that no components removed from the appliances can fall on the floor.

CAUTION**Risk of injury from heavy lifting**

If not handled correctly, carrying and installing appliances can cause injury to the limbs or torso.

- ▶ If necessary, carry and install the appliance with another person.
- ▶ Use appropriate aids to prevent damage or injury.

CAUTION**Damage from improper use**

The appliance surfaces must not be used as work or storage surfaces. This can damage the appliances (particularly in the case of hard and sharp objects).

- ▶ Never use the appliances as work or storage surfaces.
- ▶ Keep hard or sharp objects away from the appliance surfaces.

PLEASE NOTE**Faults and errors**

In the event of faults or incorrect use, error messages will be displayed.

- ▶ In the case of faults and errors, follow the instructions in the “Troubleshooting” chapter.
- ▶ In the event of any faults or errors that are not mentioned, switch the appliance off and contact BORA Service.

PLEASE NOTE

Appliance damage caused by pets

Pets may damage the appliance or injure themselves.

- ▶ Keep pets away from the appliance.

2.4 Safety information for installation

DANGER

Risk of injury from incorrect assembly

Failure to observe the installation instructions can lead to injury.

- ▶ The appliance must only be installed and assembled by trained specialists who are familiar with and comply with the standard national regulations and supplementary regulations of the local utility companies.
- ▶ The appliance may only be installed with the power disconnected.
- ▶ Work on electrical components must only be conducted by trained electrical personnel.
- ▶ Conduct all work extremely attentively and conscientiously.
- ▶ Before handing the appliance or system over to the end user, ensure that it has been correctly installed.

DANGER

Risk of electric shock from damaged appliance

A damaged appliance can cause an electric shock.

- ▶ Check the appliance for visible damage prior to installation.
- ▶ Do not install or connect any damaged appliances.
- ▶ Do not operate any damaged appliances.

DANGER

Risk of electric shock from incorrect stripping of cables

Incorrect stripping of the connection cable to external switching devices results in a risk of electric shock.

- ▶ Ensure that the connection cable is secured with the strain relief clamp within the control unit.
- ▶ Ensure that the stated stripping lengths are adhered to.

PLEASE NOTE**Appliance damage caused by incorrect wiring**

The electrical safety of the appliance is only guaranteed if it is connected to a protective conductor system that has been installed in line with regulations.

- ▶ Work on electrical components must only be conducted by trained electrical personnel.
- ▶ Ensure that this basic safety precaution is met. The appliance must be suitable for the regional voltage and frequency.
- ▶ Check the information on the identification plate and in the event of deviations, do not connect the appliance.
- ▶ Do not connect the appliance to the mains until the duct system has been installed or the recirculation filter has been fitted.
- ▶ Only use the connection cables supplied.

PLEASE NOTE**Appliance damage caused by incorrect installation clearances**

Failure to adhere to installation clearances can lead to damage to the appliance and kitchen units, as well as restricted functions.

- ▶ During installation maintain the minimum clearance stated in the Installation chapter.

2.4.1 Safety instructions – cooktop extractor installation** DANGER****Risk of smoke inhalation**

When the cooktop extractor is used in exhaust air mode, it draws in air from the room it is installed in and from neighbouring rooms. Without sufficient air, there will be a drop in air pressure. When used at the same time as a fireplace that is dependent on the air in the room, noxious gases can be sucked into the living areas from the chimney or outlet shaft.

- ▶ Make sure that there is always a sufficient air supply.
- ▶ Only use reliable, tried-and-tested switching devices, (e.g. window contact switch, low pressure warning device) and have them approved by a qualified expert (certified chimney sweep).

⚠ WARNING**Risk of injury due to turning fan wheel**

There is a risk of injury while the fan is turning.

- ▶ Only install the device with the power disconnected.
- ▶ Connect both sides of the fan to the duct system before commissioning.

CAUTION**Risk of injury due to turning fan wheel**

There is a risk of the vicinity of the fan being reached in the case of short air channels.

- ▶ Never reach through the air outlet into the vicinity of the fan.
- ▶ Always install fans so that it is not possible to touch them via the air outlet.
- ▶ In the case of air channels shorter than 900 mm between the fan and air outlet, install a guard to prevent access.
- ▶ Activated charcoal filters do not provide sufficient protection.

2.4.2 Safety information for cooktop installation**⚠ DANGER****Risk of electric shock from damaged power supply cable**

If the power supply cable is damaged (e.g. during installation or by coming into contact with hot cooking surfaces), this can cause an (lethal) electric shock.

- ▶ Make sure that the connection cable does not become trapped or damaged.
- ▶ Make sure that the power supply cable does not come into contact with hot cooking surfaces.

⚠ DANGER**Risk of electric shock from incorrect mains connection**

Connecting the appliance to the mains incorrectly poses a risk of electric shock.

- ▶ Make sure that the appliance has a fixed connection to the mains voltage.
- ▶ Make sure that the appliance is connected to a properly installed protective conductor system.
- ▶ Make sure that technical equipment is provided to enable all of the appliance's poles to be disconnected from the mains with a contact opening width of at least 3 mm (circuit breaker and automatic circuit breakers, fuses, contactor).

2.5 Safety instructions – operation

DANGER

Risk of fire from overheated oil or fat

Oil or fat in the pot can quickly heat up and ignite.

- ▶ Never leave the appliance unattended when cooking with oil or fat.
- ▶ Never extinguish oil and fat fires with water.
- ▶ Switch off the appliance.
- ▶ Extinguish the fire using a pan lid or a fire blanket, for example.

WARNING

Risk of burning from hot appliances

Certain appliances and their exposed parts become hot during use. They should be left to cool down completely after switching off. Touching hot surfaces can cause serious burns.

- ▶ Do not touch hot appliances.
- ▶ Pay attention to the residual heat indicator.

WARNING

Risk of burns due to power cut

During or after a power cut a cooktop that was previously in operation may still be hot.

- ▶ Do not touch the appliance while it is still hot.
- ▶ Keep children away from the hot appliance.

WARNING

Risk of burning and fire from hot objects

The appliance and its exposed parts are hot during operation and the cooling phase. Objects in contact with hot appliance components heat up very quickly and can cause severe burns (this particularly applies to metal objects such as knives, forks, spoons, lids or appliance components) or catch fire.

- ▶ Do not place any items on the appliance.
- ▶ Please use suitable accessories (pot holders, oven gloves).
- ▶ Do not simply rely on the pan size recognition function on induction cooktops; always switch the appliance off after use.

CAUTION

Damage caused by hot cookware

Hot cookware can damage certain components in the appliance.

- ▶ Do not put hot cookware down in the area of the operating panel or cooktop display.
- ▶ Keep hot cookware away from the air inlet nozzle.

PLEASE NOTE

Appliance damage

Incorrect use may cause damage to the appliance.

- ▶ Make sure that the base of the cookware as well as the appliance surfaces are clean and dry.
- ▶ Always lift (do not drag) cookware to prevent scratching and abrasion on the appliance surface.
- ▶ Do not use the appliance as a storage surface.
- ▶ Always switch off the appliance after use.

2.5.1 Safety instructions – cooktop extractor operation

DANGER

Risk of smoke inhalation

When the cooktop extractor is used in exhaust air mode, it draws in air from the room it is installed in and from neighbouring rooms. Without sufficient air, there will be a drop in air pressure. When used at the same time as a fireplace that is dependent on the air in the room, noxious gases can be sucked into the living areas from the chimney or outlet shaft.

- ▶ Make sure that there is always a sufficient air supply.
- ▶ Only use reliable, tried-and-tested switching devices, (e.g. window contact switch, low pressure warning device) and have them approved by a qualified expert (certified chimney sweep).

WARNING

Fire risk from flambéing

While the cooktop extractor is working, it sucks up grease from cooking. Flambéing food can cause the grease to catch fire.

- ▶ Clean the cooktop extractor regularly.
- ▶ Never work with a naked flame while the cooktop extractor is running.

CAUTION**Damage caused by objects or paper suctioned in**

Small and light items, such as cleaning cloths made from material or paper, can be suctioned into the cooktop extractor. This can damage the fan or impair the exhaust performance.

- ▶ Do not store any items or paper on the cooktop extractor.
- ▶ Only operate the integrated cooktop extractor with the grease filter fitted.

CAUTION**Damage caused by grease and dirt deposits**

Grease and dirt deposits can prevent the cooktop extractor from functioning properly.

- ▶ Never use the cooktop extractor without a correctly fitted stainless steel grease filter.

PLEASE NOTE**Increased humidity**

When cooking, additional moisture is released into the ambient air. In recirculation mode, only a slight amount of moisture is removed from the cooking vapour.

- ▶ When using the recirculation mode, ensure a sufficient supply of fresh air, e.g. by opening a window.
- ▶ Ensure a normal and comfortable room climate (humidity of 45 – 60%), e.g. by opening natural ventilation openings or using domestic ventilation systems.

2.5.2 Safety instructions – cooktop operation** DANGER****Danger of fire caused by leaving the cooktop unattended**

Oil or fat in the pot can quickly heat up and ignite.

- ▶ Never leave oil or fat to heat up unattended.
- ▶ Never extinguish oil and fat fires with water.
- ▶ Switch off the cooktop.
- ▶ Extinguish the fire using a pan lid or a fire blanket, for example.

⚠ DANGER**Danger of explosion caused by flammable liquids**

Flammable liquids in the vicinity of a cooktop can explode and cause serious injury.

- ▶ Do not spray aerosols near the appliance when it is in use.
- ▶ Do not place any flammable liquids in the vicinity of a cooktop.

⚠ WARNING**Risk of burns from hot liquids boiling over**

Unattended pans can boil over allowing hot liquids to escape.

- ▶ Keep an eye on pans when cooking.
- ▶ Avoid over-cooking.
- ▶ Always switch off the appliance after use.

⚠ WARNING**Risk of burns from hot steam**

Liquid between the cooking zone and cookware base can evaporate and cause burns.

- ▶ Make sure that the cooking zone and the cookware base are always dry.

PLEASE NOTE**Damage caused by sugary and salty foods**

Sugary and salty foods and juices can damage the hot cooking zone.

- ▶ Make sure sugary and salty foods or juices do not get onto the cooking zone while it is hot.
- ▶ Remove sugary and salty foods and juices from the hot cooking zone immediately.

CAUTION**Electromagnetic radiation**

Effect on pace makers, hearing aids and metal implants. Induction cooktops generate a high-frequency electromagnetic field in the area of the cooking zones. The cooking zones may affect pacemakers, hearing aids or metal implants negatively or disturb their function when in close proximity.

- ▶ If in doubt, contact the manufacturer of your medical device or your doctor.

2.6 Safety instructions – cleaning and maintenance

PLEASE NOTE

Appliance damage due to soiled appliances

Dirt can lead to damage, restriction of functions, or bothersome odours.

- ▶ Clean the appliance regularly.
- ▶ Remove dirt immediately.
- ▶ When cleaning, only use non-abrasive detergents to prevent scratching and abrasion on the surface.
- ▶ When cleaning, ensure that no water penetrates the appliance. Use only a slightly damp cloth. Never spray the appliance with water. Water penetration can cause damage.
- ▶ Do not use a steam cleaner for cleaning. Steam can cause a short circuit on live parts and thus lead to property damage.
- ▶ Please follow all instructions in the “Cleaning and Maintenance” chapter.

2.6.1 Safety instructions – cleaning and maintenance of cooktop extractors

DANGER

Risk of fire from fat deposits

The risk of fire can be increased by failure to clean the grease filter properly and on a regular basis, or if the filter change is overdue.

- ▶ Clean and replace the filter at regular intervals.

WARNING

Risk of injury when opening the bottom housing cover

There is a risk of injury while the fan is turning.

- ▶ Switch off the appliance and disconnect it from the mains before removing covers in the vicinity of the fan.

WARNING

Risk of injury due to turning fan wheel

If the fan wheel is turning during a filter change, this may result in injuries.

- ▶ Ensure that the appliance is switched off before changing the activated charcoal filter.

PLEASE NOTE

Appliance damage and malfunctions

Soiled ventilation openings can lead to component damage and malfunctions.

- ▶ Keep all ventilation openings open and clean.

2.6.2 Safety instructions – cleaning and maintenance of cooktops

WARNING

Risk of burns from hot surfaces

There is a risk of burns when cleaning hot cooktops.

- ▶ Only clean the cooktops once they have cooled.
- ▶ Pay attention to the residual heat indicator.

2.7 Safety instructions – repairs, servicing and spare parts

DANGER

Risk of injury when carrying out repairs

Insufficient expertise can lead to injury when carrying out repairs.

- ▶ The appliance must only be repaired and serviced by trained specialists who are familiar with and comply with the standard national regulations and supplementary regulations of the local utility companies.
- ▶ Safely disconnect the appliance from the mains supply.
- ▶ Work on electrical components must only be conducted by trained electrical personnel.
- ▶ A damaged power supply cable must be replaced by a suitable power supply cable.

WARNING

Risk of injury or damage from improper repairs

Incorrect components can lead to personal injury or damage to the appliance. Modifications, additions or alterations to the appliance can lead to safety risks.

- ▶ Only use original spare parts for repairs.
- ▶ Do not make any modifications, additions or alterations to the appliance.

2.8 Safety instructions – disassembly and disposal

DANGER

Risk of injury during disassembly

Insufficient expertise can lead to injury when disassembling the appliance.

- ▶ It must only be disassembled by trained specialists who are familiar with and comply with the standard national regulations and supplementary regulations of the local utility companies.
- ▶ Safely disconnect the appliance from the mains supply.
- ▶ Work on electrical components must only be conducted by trained electrical personnel.

DANGER

Risk of electric shock from incorrect disconnection

Incorrectly disconnecting the appliance from the mains results in a risk of electric shock.

- ▶ Safely disconnect the appliance from the mains supply.
- ▶ Use an authorised measuring device to ensure that there is no power to the appliance.
- ▶ Do not touch exposed contacts on the electronic unit as they may contain residual charge.

DANGER

Risk of electric shock from residual charge

Electrical components in the appliance can contain residual charge and cause an electric shock.

- ▶ Do not touch any exposed contacts.

3 Technical data

3.1 M Pure

Parameter	Value
Multiphase supply voltage	380-415 V 2N/3N
Single-phase supply voltage	220-240 V
Frequency	50-60 Hz
Maximum power consumption	7600 W (4400 W/3600 W)
Three-phase power supply/ fuse protection	3 x 16 A
Two-phase power supply/ fuse protection	2 x 16 A
Single-phase power supply/ fuse protection	1 x 32 A (1 x 20 A / 1 x 16 A)
Dimensions (width x depth x height)	760 x 515 x 199 mm
Weight (incl. accessories/packaging)	21.8 kg (PURMA) 23.6 kg (PURMU)

Cooktop

Surface material	Glass ceramic
Cooktop power levels	1-9, P
Front left cooking zone size	Ø 210 mm
Front left cooking zone output	2300 W
Front left cooking zone power setting output	3000 W
Rear left cooking zone size	Ø 175 mm
Rear left cooking zone output	1400 W
Rear left cooking zone power setting output	2100 W
Front right cooking zone size	230 x 230 mm
Front right cooking zone output	2100 W
Front right cooking zone power setting output	3000 W
Rear right cooking zone size	230 x 230 mm
Rear right cooking zone output	2100 W
Rear right cooking zone power setting output	3000 W

Exhaust air system

Cooktop extractor power levels	1-9, P
Exhaust air connection	BORA Ecotube

Recirculation system

Parameter	Value
Cooktop extractor power levels	1-9, P
Size of exhaust opening (W x H)	445 x 137 mm
Activated charcoal filter service life	150 hrs (1 year)

Tab. 3.1 Technical data for M Pure

3.1.1 PURMA appliance dimensions

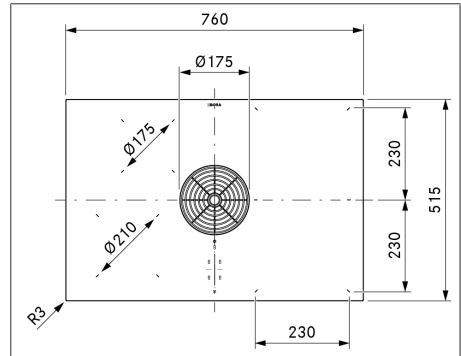

Fig. 3.1 PURMA appliance dimensions top view

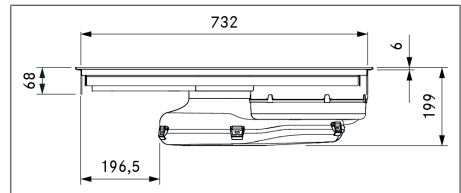

Fig. 3.2 PURMA appliance dimensions front view

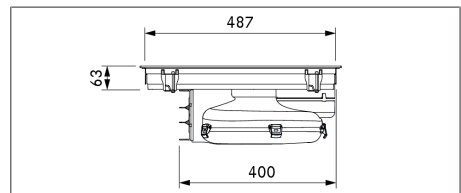

Fig. 3.3 PURMA appliance dimensions side view

3.1.2 PURMU appliance dimensions

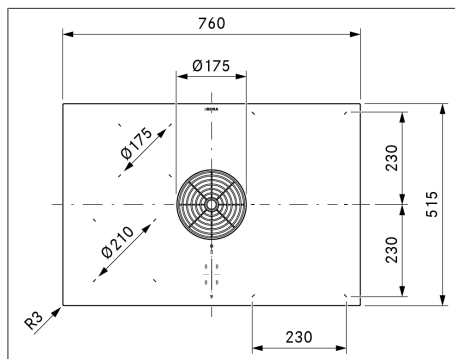

Fig. 3.4 PURMU appliance dimensions top view

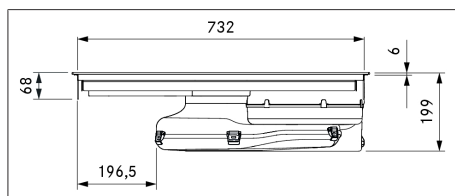

Fig. 3.5 PURMU appliance dimensions front view

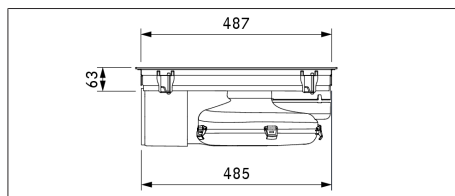

Fig. 3.6 PURMU appliance dimensions side view

4 Appliance description

- Observe all safety and warning information (see "2 Safety").

4.1 Model description

Model	Long description
PURMA	M Pure induction/surface induction cooktop with integrated cooktop extractor - exhaust air
PURMU	M Pure induction/surface induction cooktop with integrated cooktop extractor - recirculation

Tab. 4.1 Model description

Layout and technology:

2 left cooking zones = induction

2 right cooking zones = surface induction

4.2 System description

4.2.1 Structure

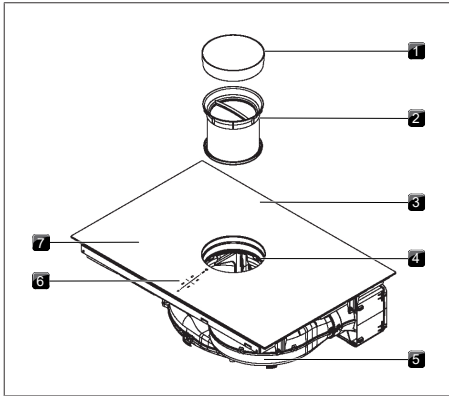

Fig. 4.1 Structure

- [1] Air inlet nozzle
- [2] Stainless steel grease filter
- [3] Cooktop
- [4] Inlet opening
- [5] Fans
- [6] Operating panel
- [7] Cooking zone (x 4)

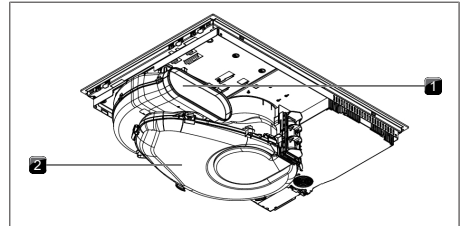

Fig. 4.2 Exhaust air variant rear view

- [1] Exhaust opening
- [2] Air guiding housing with housing base

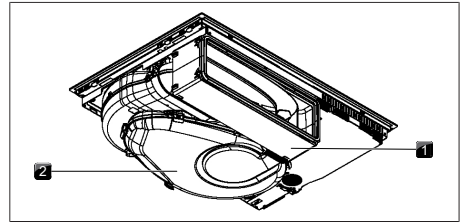

Fig. 4.3 Recirculation variant rear view

- [1] Air purification box with telescopic pull-out
- [2] Air guiding housing with housing base

4.2.2 Operating panel

The appliance is operated via a central touch operating panel.

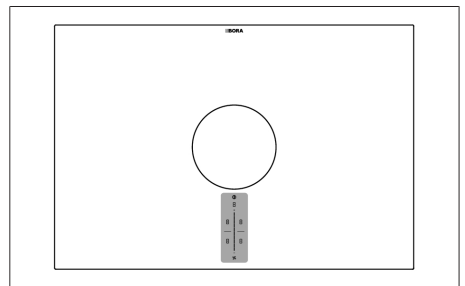

Fig. 4.4 Central touch operating panel with touch slider

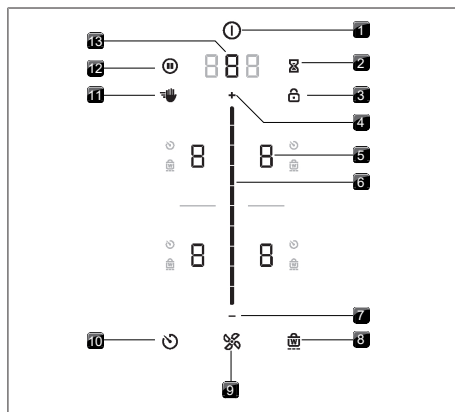

Fig. 4.5 Touch zones/buttons

- [1] Switching on/off
- [2] Short-time timer (egg timer)
- [3] Operating lock
- [4] Plus setting area
- [5] Cooking zone selection (x 4)
- [6] Touch slider (setting area)
- [7] Minus setting area
- [8] Heat retention function
- [9] Fan functions
- [10] Cooking zone timer
- [11] Cleaning lock
- [12] Pause function
- [13] Select fan/Call up menu

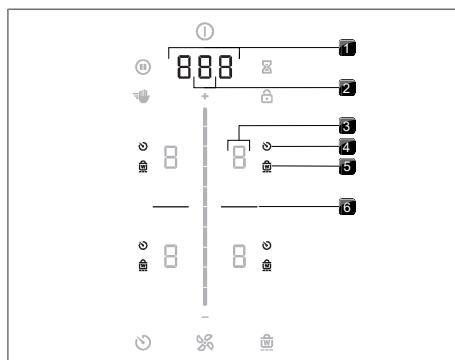

Fig. 4.6 Indicator zones

- [1] Multi-function display
- [2] Fan display
- [3] Cooking zone indicator (x 4)
- [4] Cooking zone timer indicator (x 4)
- [5] Heat retention function indicator (x 4)
- [6] Dividing line

4.2.3 Symbols

Symbol	Designation	Function/meaning
	Power button	Switching on/off
	Pause button	Pause function activation/deactivation
	Cleaning button	Cleaning lock activation/deactivation
	Short-time timer button	Setting the short-time timer (egg timer)
	Lock button	Control lock
	Slider	Setting values
	Plus button	Increasing values
	Minus button	Decreasing values
	Fan button	Automatic extractor function activation/deactivation, Accept after-run function
	Timer button	Setting the cooking zone timer
	Warming button	Heat retention function activation/deactivation

Tab. 4.2 Meaning of the symbols displayed (icons)

4.2.4 7-segment display

Multi-function display	Meaning
Fan display	1-9 Power levels
	P Power setting
	0 Inactive
	A Automatic extractor function
	⌋ Automatic after-run
	F Filter service display
Multi-function display	000 Time indication
	e.g. E Error code

Multi-function display	Meaning
Cooking zone indicator	Meaning
Cooking zone indicator	1-9 Power level
	P Power setting
	- Heat retention level
	U Pan size recognition
	□ Inactive
	H Residual heat indicator (cooking zone is switched off but still hot)
	E Error

Tab. 4.3 Meaning of the 7-segment displays

4.2.5 Lighting

- i** The lighting of the displays (bright or dark) is automatically adapted by the appliance to the current operating conditions. Unavailable functions are faded out.

Lighting	Use
100%	Function is active and selected
50%	Function is inactive and can be selected
0%	Function is unavailable

Tab. 4.4 Lighting

4.2.6 Sounds

- i** The volume of the acoustic signals can be set in the menu.

The system distinguishes between different signal acoustic signals:

Acoustic signal	Purpose
Short beep (0.25 s)	Confirmation of a selection
Sequence of beeps	Interaction required

Tab. 4.5 Sounds

4.3 How the cooktop extractor works

The cooktop extractor is either operated as an exhaust air system or recirculation system.

Exhaust air operating mode

The cooking vapour is guided by the fan into the open air via the duct system.

Recirculation operating mode

The cooking vapour is guided by the fan into the activated charcoal filter and the air cleaned in this way is released back into the room.

For health and hygiene reasons, the activated charcoal filter must be replaced at the recommended intervals (Cleaning and maintenance).

- i** In recirculation mode, ensure sufficient ventilation and aeration to expel humidity.

4.4 How the induction cooktop works

Induction cooking zones heat the cookware via a magnetic field. The pot base is heated directly. The cooking zone is only heated indirectly. Cooking zones featuring induction technology only work with suitable cooking cookware (magnetisable base). Only the surface that is covered by the pot base will be heated.

Power levels

The high power output of induction cooktops results in the very quick heating up of cookware. In order to avoid burning food, slight adjustment is needed in comparison to conventional cooking systems when selecting the power level.

Activity	Power level
Melting butter and chocolate, breaking up gelatine	1
Keeping sauces and soups warm, soaking rice	1-3
Cooking potatoes, pasta, soups and ragouts, steaming fruit, vegetables and fish, defrosting food	2-6
Frying in coated pans, moderate frying (without overheating the fat) of pork cutlets or fish	6-7
Heating up fat, browning meat, cooking thickened sauces and soups, making omelettes	7-8
Bringing large amounts of liquid to the boil, searing steaks	9
Heating up water	P

Tab. 4.6 Recommendations for power levels

The specifications provided in the table are standard values. Depending on the cookware and filling quantity, it is recommended to either decrease or increase the power level.

Suitable cookware

Cookware with this symbol is suitable for induction cooktops.

Suitable cookware is made of:

- stainless steel with a magnetisable base
- enamelled steel
- cast iron

► Observe the minimum cookware base diameter:

Appliance	Cooking zone	Minimum cookware base diameter
M Pure	Front left	120 mm
	Rear left	90 mm
	Front right	120 mm
	Rear right	120 mm

Tab. 4.7 Minimum cookware diameter

- Perform a magnet test, if necessary. If a magnet sticks to the base of the utensils, they are normally induction compatible.
- Place the cookware (without a mat or similar) directly onto the glass ceramic.

i The heating and heat-through times and cooking results are significantly influenced by the structure and material of the cookware.

i The cookware base must not be warped or have any sharp grooves or sharp edges. If the base is warped, the cookware may not be recognised or may overheat. Sharp grooves or edges may scratch the cooktop surface.

Noises

When operating induction cooktops, noises may occur due to material and processing of the cookware (humming, crackling, whistling, clicking or buzzing).

5 Functions and operation

- Observe all safety and warning information (see "2 Safety").

- i** The integrated cooktop extractor must not be used with other cooktops.
- i** The appliance should only be operated when the filter replacement cover, stainless steel grease filter and air inlet nozzle are installed (as well as the activated charcoal filter in the recirculation model).

5.1 General operating instructions

The appliance is operated via a central touch operating panel. The operating panel is equipped with touch zones and display zones. Operate the appliance with your finger, touch controls and swipe gestures (slider operation).

5.2 Touch control

The system recognises different touch commands.

Touch commands	Applicable to	Time (contact)
Tap	Buttons + slider	0.3 s
Long press	Buttons + slider	1–8 s
Swipe	Slider	0.1–8 s

Tab. 5.1 Touch control

5.3 Function overview

Features	PURMA	PURMU
Electronic power adjustment	✓	✓
Short-time timer (egg timer)	✓	✓
Cooktop extractor functions		
Automatic extractor function	✓	✓
Automatic after-run	✓	✓
Power setting	✓	✓
Filter service display		✓
Cooktop functions		
Automatic heat up function	✓	✓
Pan size recognition	✓	✓

Features	PURMA	PURMU
Permanent pan size recognition	✓	✓
Heat retention function	✓	✓
Bridging function (right cooking zone)	✓	✓
Automatic bridging function (right cooking zone)	✓	✓
Cooking zone timer	✓	✓
Pause function	✓	✓
Power setting	✓	✓
Safety features		
Child lock	✓	✓
Operating lock	✓	✓
Cleaning lock	✓	✓
Residual heat indicator	✓	✓
Safety shut-down	✓	✓
Overheating protection	✓	✓

Tab. 5.2 Function overview

5.4 Operating the system

5.4.1 Switch on/off

- Long press on the power button .

Switching on the system:

After start-up, the standard display will appear in the operating panel:

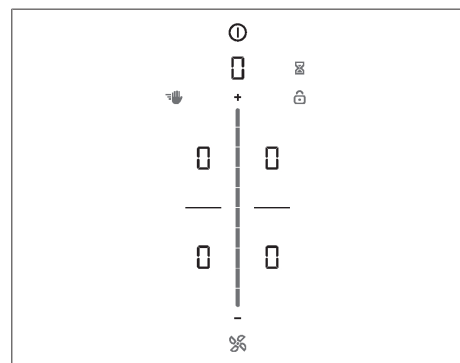



Fig. 5.1 Standard display after switching on

- i** When the child lock is active, the lock button lights up after system start .

After switching off:

If the cooktop was switched on, after switching it off the fan's after-run function will start. The display goes out when the after-run time has lapsed.

If the cooktop was switched on and there are cooking zones that are still hot, the residual heat indicator  will be displayed zones. The display goes out when no more residual heat is present.

5.4.2 Short-time timer

The short-time timer emits both a visual and an acoustic signal after a time set by the user and provides the function of a conventional egg timer.





Activating the short-time timer

- ▶ Tap the short-time timer button .

The time flashes in the multi-function display above the slider in minutes (.

Setting the time

- ▶ Set the desired time:

Command	Increase time	Decrease time
Swipe	 upwards	 downwards
Tap	 (exact to the minute)	 (exact to the minute)

Tab. 5.3 Setting the time

- The short-time timer button  begins to flash.

Starting the short-time timer

- ▶ Tap the flashing short-time timer button .

The set time starts to count down. The remaining time is shown on the multi-function display.

Time lapsed

In the last 10 seconds of the countdown, the remaining time will flash and is displayed down to the second. In the last 5 seconds you will hear a sound.

Deactivating the short-time timer early





- ▶ Long press on the short-time timer button .

- i** If the appliance is switched off, the short-time timer will remain active.

5.5 Cooktop extractor functions

5.5.1 Setting the fan power levels



The fan power levels can be adjusted in different ways:

- ▶ by tapping  or 
- ▶ adjustment using the slider 
- ▶ by tapping a certain position on the slider 

5.5.2 Fan power setting

When the power setting is activated, maximum extractor power is available for a predefined time. After 5 minutes, the power setting is automatically switched back to power level 9.

Activating the fan power setting

- ▶ Tap  when power level 9 is active.
-  appears in the fan display.

Deactivating the fan power setting

The fan power setting is deactivated early if another power level is set.

5.5.3 Automatic extractor function



The extractor power is automatically adjusted to the highest power level used on all cooking zones that are currently in use.

- If the cooking zone power level is changed, the extractor power is automatically adjusted. The extractor power is adjusted after a 20 second delay.

Function	Power levels
Cooking level	1 2 3 4 5 6 7 8 9 P
Extractor power	4 4 4 4 5 6 7 8 9 P

Tab. 5.4 Extractor power when automatic extractor function is active

Activating the automatic extractor function for a cooking session:



- ▶ tap the fan button .
-  is displayed.

Deactivating the automatic extractor function:

- ▶ Swipe to a fan power level.
- or
- ▶ tap the fan button .

5.5.4 Switching the fan off



Switching the fan off

- ▶ Swipe downwards to power level 0
- or
- ▶ tap  until power level 0 is reached
- or
- ▶ long press on the fan button 
- or
- ▶ Long press on the fan power level in the multi-function display.
- When the extractor is switched off, the automatic after-run function is activated.

5.5.5 Automatic after-run

The cooktop extractor continues to run at a lower level and switches off automatically after a defined time. The duration of the after-run function can be set in the menu (factory setting is 20 minutes).

Switching off the automatic after-run early

- ▶ Long press on the fan button 
-  BORA expressly recommends use of the cooktop extractor after-run function.



5.5.6 Filter service display

The cooktop extractor filter service display is automatically activated when the end of the activated charcoal filter service life is reached (only in recirculation mode).

- **F** is displayed in the multi-function display.
- The filter service display is shown every time the cooktop extractor is switched on and remains active until the filter has been changed and the filter service display has been reset (see "6.3 Menu item 3: Show filter status and reset filter service display").
- The cooktop extractor can still be operated without limitations.
-  The components of the grease filter require regular cleaning regardless of the filter service display, see "8 Cleaning and Maintenance".

5.6 Cooktop functions

5.6.1 Pan size recognition

On induction cooktops the cooking zone recognises the size of the cookware automatically and only targets the energy at that area. An induction cooking zone is not working if the display alternates between  / .

Possible causes:

- Missing cookware
- Unsuitable cookware
- The base diameter of the cookware is too small

If no pot is detected 10 minutes after setting a power level, the cooking zone will switch off automatically.

Permanent pan size recognition

The appliance automatically recognises cookware and activates the corresponding cooking zone controls. Manual selection of the cooking zone is not necessary (see "6.7 Menu item 7: Permanent pan size recognition").



-  Do not simply rely on the pan size recognition function on induction cooktops; always switch the appliance off after use.

5.6.2 Selecting a cooking zone



- ▶ Tap the cooking zone display.
- The cooking zone operation is activated and settings can be changed for 2 seconds.

5.6.3 Setting cooking zone power levels

After selecting the cooking zone, the power level can be set in 3 different ways:

- ▶ by swiping until you reach the required power level
- or
- ▶ by tapping a certain position on the slider
- or
- ▶ by tapping  or .

Repeat this process to operate further cooking zones if necessary.



-  The power level set is shown in the respective cooking zone display.
-  Two seconds after the power level is changed, the operating panel display automatically returns to the standard display.

5.6.4 Cooking zone power setting

When the power setting is activated, maximum cooking zone power is available for a cooking zone. After 5 minutes, the power setting is automatically switched back to power level 9. For the second cooking zone on the same side, the maximum power is temporarily lowered to power level 7.

-  If the power setting is set too high for the second cooking zone, the power setting will be automatically reset to power level 9 for the other cooking zone.

Activating the power setting for a cooking zone

- ▶ Tap  when power level 9 is active.
-  appears in the cooking zone display.

Deactivating the power setting early

- ▶ Setting another power level

-  Never heat up oil, fat and the like on the power setting. The bottom of the pan can overheat due to the high power output.

5.6.5 Automatic heat up function

When the automatic heat up function is activated, the cooking zone works at full power for a certain amount of time and is then automatically reset to the previously set level.

Power level	Cooking duration in min:sec.
1	0:40
2	1:00
3	2:00
4	3:00
5	4:20
6	7:00
7	2:00
8	3:00

Tab. 5.5 Heating time overview

Activating the automatic heat up function

Prerequisite: Cooking zone is active (power level is set)

- ▶ Long press on the slider  at a position lower than power level 9

- Whilst the automatic heat up function is active, the power level displayed will flash.

Deactivating the automatic heat up function early

- ▶ Setting a lower power level



-  If the power level is increased while the automatic heat up function is active, the heat up function is automatically adjusted.

5.6.6 Cooking zone timer

This automatic cut-off function automatically switches off the selected cooking zone once a preset time has lapsed. The timer function can also be used on several cooking zones at the same time (multi-timer).





Activating cooking zone timers

Prerequisite: Cooking zone is active (power level is set)

- ▶ Tap the timer button .
- The time flashes in the multi-function display above the slider in minutes (.

Setting the time

- ▶ Set the desired time:

Command	Increase time	Decrease time
Swipe	 upwards	 downwards
Tap	 (exact to the minute)	 (exact to the minute)

Tab. 5.6 Setting the time

Start timer

- ▶ Tap the flashing timer button .
- The set time starts to count down. The remaining time is shown on the multi-function display.

Showing the remaining time

- ▶ Tap the cooking zone display with an active timer
- The remaining time is shown in the multi-function display.

Changing active timers

- ▶ Tap the cooking zone display with an active timer
- ▶ Tap the timer button .
- The timer is stopped.
- The remaining time flashes in the display.
- ▶ Change the set time and restart the timer.

Multi-timer

- ▶ Repeat the process for additional cooking zones.

Switching the timer off early

- ▶ Tap the cooking zone display with an active timer
- ▶ Long press on the timer button 
- or
- ▶ long press on the cooking zone display with an active timer
 - The cooking zone remains active on the set power level.

Time lapsed

In the last 10 seconds of the countdown, the remaining time will flash and is displayed down to the second. In the last 5 seconds you will hear a sound.

At the end of the set time the cooking zone is automatically deactivated (= power level )

5.6.7 Pause function

With the pause function all cooking zones can be quickly and easily deactivated temporarily. The cooking processes can be interrupted for a maximum of 10 seconds. If the pause function is deactivated, operation will resume with the original settings. Once 10 minutes have lapsed, the cooking session is automatically ended.

-  The fan function, the bridging function and the (active) minute minder cannot be interrupted. Active cooking zone timers are stopped.

Activating the pause function

- ▶ Tap the pause button 



Deactivating the pause function

- ▶ Long press the pause button 

5.6.8 Heat retention function

The heat retention function enables meals that have already been cooked to be kept warm without risk of burning. The maximum duration of the heat retention function is limited to 8 hours.

Activating the heat retention function

- ▶ Selecting a cooking zone
- ▶ Tap the heat retention button 
 -  and next to it the heat retention symbol  is shown on the cooking zone display.



Deactivating the heat retention function

- ▶ Tap the heat retention button 
- or
- ▶ Set a power level

5.6.9 Bridging function

-  Function only available with the 2 surface induction cooking zones on the right.

With the bridging function, two cooking zones located one behind the other can be combined to form one large cooking zone. The power for the combined zones is then adjusted by a single operating control. Power adjustment takes place simultaneously (both cooking zones are operated on the same power level). The bridging function is suitable for heating food, e.g. in a roaster.

-  If both cooking zones are active before the bridging function is activated, the lower power level is adopted. If timers are active on the cooking zones, the lower timer value will be adopted for the bridging timer.
-  The bridging function finishes and the cooking zones are deactivated if no suitable cookware is detected (pan size recognition) on any or only one of the two cooking zones for 10 seconds.

Activating the bridging function

- ▶ Tap both cooking zone displays at the same time.
 - Both cooking zone displays show the same power level.
 - Active additional cooking zone functions are adopted (dual display).

Deactivating the bridging function

- ▶ Long press on one of the two cooking zone displays with an active bridging function
- or
- ▶ tap both cooking zone displays with an active bridging function simultaneously.
 - The power levels are set to 0.
 - If a cooking zone timer was active, it is deactivated.

5.6.10 Automatic bridging function

If a large enough piece of cookware (e.g. grill pan or roasting tray) is placed on the two cooking zones that are one behind the other, they will automatically be combined to form one large cooking zone. The bridging function does not need to be activated manually.

-  If the permanent pan size recognition function is switched on (see "6.7 Menu item 7: Permanent pan size recognition"), the automatic bridging function is also activated.

5.6.11 Switching off the cooking zone

- ▶ Selecting a cooking zone
 - ▶ Set power level to 0
- or
- ▶ long press on the cooking zone display

5.7 Safety features

5.7.1 Child lock

The child lock prevents the appliance from being switched on accidentally.

- After switching on the appliance, the lock symbol  lights up in the operating panel display.

Permanently activating/deactivating the child lock

(see "6.2 Menu item 2: Child lock")

Deactivating the child lock for a cooking session

- ▶ Long press on the lock button .

5.7.2 Operating lock

The control lock prevents the current settings from being changed accidentally or without permission.

- If the control lock is active, the symbol  lights up
- The functions are locked and the indicators on the display are dimmed (exception: On/Off touch button).

Activating/deactivating the operating lock

- ▶ Long press the lock button .

All functions are deactivated except for the power button and the lock button.

-  If the system is switched off when the control lock is active, the operating lock will no longer be active next time the system is switched on.

5.7.3 Cleaning lock

The cleaning lock prevents settings from being changed when wiping the operating panel during a cooking session. All appliance settings remain unchanged in the meantime.

Activating the cleaning lock

- ▶ Tap the cleaning button .

The operating panel is locked for 10 seconds.

Prematurely deactivating the cleaning lock

- ▶ long press on the cleaning button .

5.7.4 Residual heat indicator

If a cooking zone is still hot after switching off, there is a risk of burns or fire. H is displayed (residual heat indicator).

- ▶ Do not touch hot cooking zones.
- ▶ Do not place any objects on the cooking zones while hot.

The display goes out after a sufficient cooling time (temperature < 55°C).

5.7.5 Safety shut-down

Cooktop extractor

The cooktop extractor switches to automatic mode after 120 min if there has been no input or changes to the power level.

Cooktops

Each cooking zone is automatically switched off after a predefined operating time in which the power level has not been changed. The period of time until safety shut-down is triggered can be set in the customer menu. There are 3 levels to choose from (factory setting is level 2).

Power level	Safety shut-down after hrs:min.		
	Level 1	Level 2	Level 3
1	12:00	8:24	6:00
2	10:00	6:24	4:00
3	9:00	5:12	2:30
4	8:00	4:12	2:00
5	6:00	3:18	1:30
6	4:00	2:12	1:00
7	4:00	2:12	1:00
8	3:00	1:48	0:45
9	2:00	1:18	0:30
P	0:05	0:05	0:05

Tab. 5.7 Safety shut-down on the different power levels

Heat retention level	Safety shut-down after hrs:min.		
	Level 1	Level 2	Level 3
	12:00	8:00	4:00

Tab. 5.8 Safety shut-down on the different heat retention levels

5.7.6 Overheating protection

 In the event of overheating, the cooktop power is reduced or the appliance is switched off completely.

The appliance is fitted with overheating protection. The overheating protection can be triggered if:

- cookware is heated up empty;
- oil or fat is heated on high power;
- a hot cooking zone is switched on again after a power cut.

Whilst the overheating protection is active, one of the following steps is taken:

- the activated power setting is switched back to the previous level;
- the power setting can no longer be switched on;
- the set power level is reduced;
- the cooktop switches off completely.

After a sufficient cooling period, the cooktop can be used again in full.

6 User menu

Certain functions can be set in the user menu.

Calling up the user menu

Prerequisite: The appliance is switched on, all cooking zone and the cooktop are inactive and there is no residual heat.

- ▶ Long press on the multi-function display.
 - The menu is called up and the first menu item is displayed.

Navigating the user menu

Navigate to the next menu item:

- ▶ Tap the multi-function display.
 - Any changed settings are automatically applied when changing to another menu item or when exiting the menu.

Closing the user menu



- ▶ Long press on the multi-function display.
- or
- ▶ long press on the power button 
 - The menu is closed and the appliance is switched off.

User menu overview

Menu item/Description/Selection	Factory setting
1 Volume of the acoustic signals (0–9)	4
2 Child lock (On/Off)	Off
3 Show filter status (reset filter service display)	
4 Duration of the automatic after-run function (10, 15, 20 min.)	20 min
5 Touch zone reaction speed (1 slow, 2 medium, 3 fast)	2
6 LED test	
7 Permanent pan size recognition	Off
8 Software/hardware version	
9 Safety shut-down (1 long, 2 medium, 3 short)	2
A Super simple mode	Off
0 Reset to factory settings	

Tab. 6.1 User menu overview

6.1 Menu item 1: volume of the acoustic signals

-  Safety-relevant acoustic signals are always emitted with the volume at 100%.
-  The acoustic signal for the power button cannot be deactivated.
-  After accessing the menu item, the currently set volume is displayed.

Setting the acoustic signal volume:

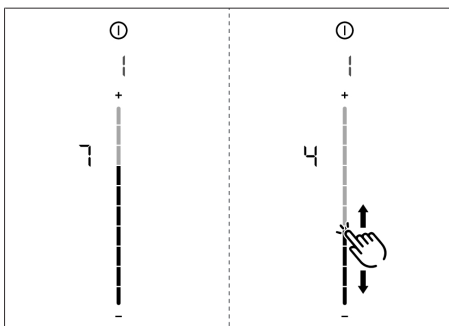



Fig. 6.1 Menu item 1: volume of the acoustic signals

6.2 Menu item 2: Child lock

-  With menu item 2 the child lock can be permanently switched on or off.

Permanently activating or deactivating the child lock:

- ▶ Tap the top slider segment  to activate
- ▶ Tap the bottom slider segment  to deactivate

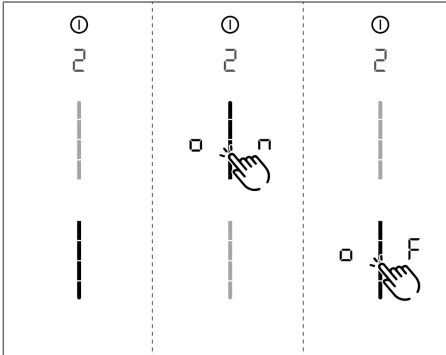



Fig. 6.2 Menu item 2: Child lock

6.3 Menu item 3: Show filter status and reset filter service display

i If menu item 3 is called up, the filter status will be automatically shown (only in recirculation mode).

Resetting the filter service display:

- ▶ Long press on the fan button .
- The filter status will be reset to 100%.
- The filter service display  will no longer be shown when switching on.

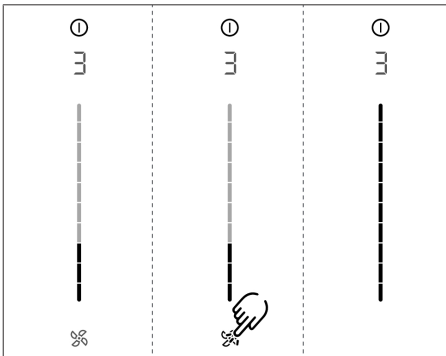

Fig. 6.3 Menu item 3: Reset filter status and the filter service display

6.4 Menu item 4: Duration of the automatic after-run function

i If menu item 4 is called up, the currently set duration will be shown for 2 seconds.

There are three times to choose from:
20 minutes / 15 minutes / 10 minutes

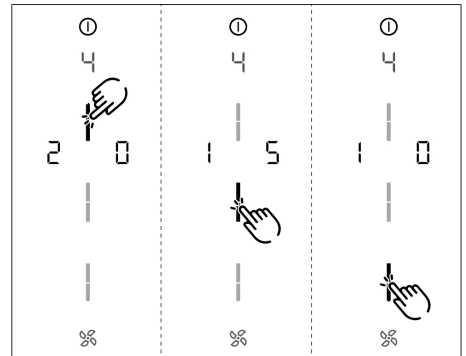





Fig. 6.4 Menu item 4: Selecting the duration of the automatic after-run function

6.5 Menu item 5: Touch zone reaction speed

i If menu item 5 is called up, the currently set reaction speed will be shown.

- Reaction speed : slow
- Reaction speed : medium
- Reaction speed : fast

Selecting the reaction speed:

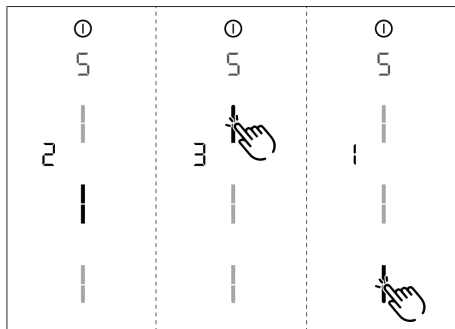



Fig. 6.5 Menu item 5: Reaction speed

6.6 Menu item 6: LED test

i Function inspection of all LEDs in the touch zones.

Starting the LED test:

- ▶ Tap the slider zone .
- All indicators are displayed at 50 % brightness.
- ▶ Tap any indicator you wish.
- The selected indicator will be displayed at 100% brightness for 1 second for testing purposes.
- Any other indicators can be tested by touch.

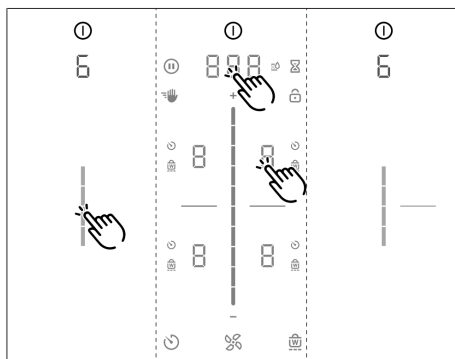

Fig. 6.6 Menu item 6: LED test

Ending the LED test:

- ▶ Long press on the multi-function display.

i The LED test will be automatically ended when there has been no activity for 5 seconds.

6.7 Menu item 7: Permanent pan size recognition

i Switch permanent pan size recognition permanently on or off.

Activate or deactivate permanent pan size recognition:

- ▶ Tap the top slider segment  to activate.
- ▶ Tap the bottom slider segment  to deactivate.

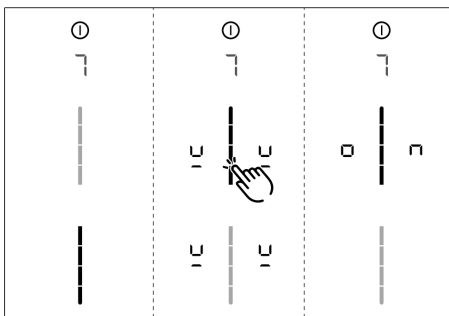

Fig. 6.7 Menu item 7: Permanent pan size recognition

6.8 Menu item 8: Show software/hardware version

i The software/hardware version is shown via the four 4 cooking zones indicators.

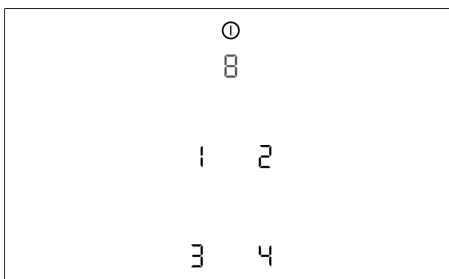

Fig. 6.8 Menu item 8: Software/hardware version

6.9 Menu item 9: Safety shut-down

i The time span (level) until automatic safety shut-down of the cooking zones can be selected using menu item 9.

The current level is displayed:

- Level 1: long time span until automatic safety shut-down
- Level 2: medium time span until automatic safety shut-down (factory setting)
- Level 3: short time span until automatic safety shut-down

Selecting the level:

Fig. 6.9 Menu item 9: Safety shut-down

6.10 Menu item A: Super simple mode

The following additional functions and their indicator are deactivated in the super simple mode:

- Cooking zone timer
- Short-time timer
- Cleaning lock
- Operating lock
- Heat retention function
- Pause function

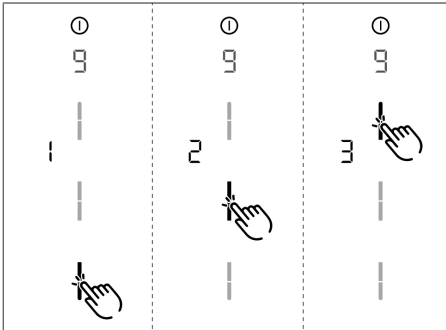
Activating or deactivating super simple mode:

- ▶ Tap the top slider segment  to activate.
- ▶ Tap the bottom slider segment  to deactivate

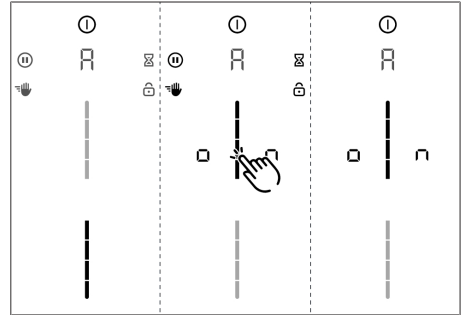



Fig. 6.10 Menu item A: Super simple mode

6.11 Menu item 0: Reset to factory settings

-  Menu item 0 enables all settings in the user menu to be reset to the factory settings.

Resetting to factory settings

- ▶ Long press on the slider zone .
- After resetting, the appliance is switched off.

7 Cleaning and maintenance

- ▶ Observe all safety and warning information (see "2 Safety").
- ▶ When conducting cleaning and maintenance, ensure that the cooktop and cooktop extractor are fully switched off and cooled so as to prevent injury.
- ▶ Adhere to the following cleaning and maintenance cycles:

Component	Cleaning cycles
Operating panel	Immediately after every soiling
Cooktop	Clean well immediately after soiling, using conventional detergents
Cooktop extractor	Weekly
Air inlet nozzle and stainless steel grease filter	<ul style="list-style-type: none"> ● After cooking very greasy dishes, but at least once a week ● If filter service indicator F appears ● by hand or in the dishwasher (at 65°C max.) ● Clean the stainless steel surfaces in the polishing direction only
Air guiding housing	Every 6 months or when replacing the activated charcoal filter
Activated charcoal filter (with recirculation only)	Replace if odours have built up, extraction power is dwindling or filter service indicator F appears

Tab. 7.1 Cleaning cycles

- i** Regular cleaning and maintenance ensures long service life of the product and optimal function.

7.1 Cleaning agents

- ▶ Do not use any chemically aggressive cleaning agents or agents containing acid or lye (e.g. oven spray).
- ▶ Make sure that the cleaning agent does not contain any sand, soda, acids, lyes or chloride.
- ▶ Never use a steam cleaner, abrasive sponges or scouring pads.

- i** Aggressive cleaning agents and abrasion caused by the pot bases will damage the surface and dark stains will occur.

7.2 Cooktop and extractor care

- ▶ Keep the appliance clean and immediately remove any and all contamination.
- ▶ Never use the cooktop as a work or storage surface.
- ▶ Only use suitable cookware with the appliance.
- ▶ Do not push or pull cookware over the cooktop.
- ▶ Always lift pots and pans.

Any changes in colour or glossy spots do not mean that the cooktop is damaged. They do not affect the functionality of the cooktop or the stability of the glass ceramic panel.

Changes in the colour of the cooktop are the result of residues which have not been removed and have burnt on.

Glossy spots are the result of wear by the pan base, especially if aluminium-based cookware or unsuitable cleaning agents are used. These are difficult to remove.

7.3 Cleaning the cooktop

- i** To clean the cooktop, you need a special glass ceramic scraper and suitable cleaning agents.

Scheduled cleaning

- ▶ Remove all coarse dirt and food residues from the cooktop using a glass ceramic scraper.
- ▶ Apply the cleaning agent to the cold cooktop.
- ▶ Spread the cleaning agent using kitchen roll or a clean cloth.
- ▶ Wipe the cooktop clean with a damp cloth.
- ▶ Dry the cooktop with a clean cloth.

Heavy soiling

- ▶ Remove heavy soiling and marks (limescale marks, mother-of-pearl-like shiny marks) using cleaning products while the cooktop is still warm.
- ▶ Wipe off any food that boils over with a damp cloth.
- ▶ Remove any remaining dirt with the glass ceramic scraper.

Surface cleaning during operation

- ▶ Always remove any seeds, crumbs or similar that fall onto the cooktop during cooking immediately to prevent the surface getting scratched.

- ▶ Remove stubborn residues of plastic, aluminium foil, sugar or sweet dishes from the hot cooking zone immediately using a glass ceramic scraper to prevent burning.

i When the cooktop extractor is in use the air inlet nozzle must be fitted so that no small or light objects such as fabric or paper cleaning cloths can be sucked in.

7.4 Cleaning the cooktop extractor

- ▶ Clean the surfaces of the extraction system using a soft, damp cloth, detergent or a mild window cleaning agent.
- ▶ Soften dried on dirt using a damp cloth (do not scrape it off!).

7.4.1 Cleaning the air inlet nozzle and stainless steel grease filter

i The air inlet nozzle and stainless steel grease filter absorb the greasy particles from cooking vapours.

Removing the components

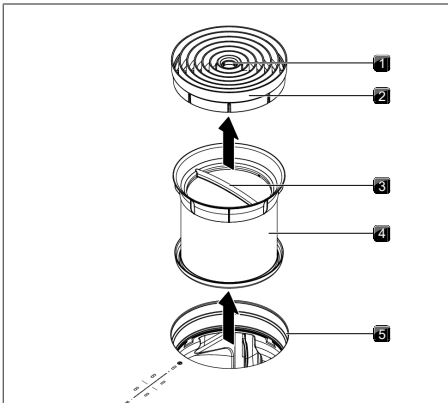

Fig. 7.1 Removing the components

- [1] Access opening
- [2] Air inlet nozzle
- [3] Handle
- [4] Stainless steel grease filter
- [5] Inlet opening

Manual cleaning

- ▶ Use a cleaner and degreaser in one.
- ▶ Rinse the components with hot water.
- ▶ Clean the components with a soft brush.
- ▶ Rinse the components well after cleaning.

Cleaning in the dishwasher

- ▶ Remove coarse food residues from the components.
- ▶ Place the components in the dishwasher.
- ▶ No water should be able to gather in the components.
- ▶ Rinse the components with a rinsing program at a maximum temperature of 65°C.

i To prevent water from dripping into the appliance, it is recommended to shake the components well after cleaning and dry with a towel if necessary.

i If the stainless steel grease filter can no longer be fully cleaned, it must be replaced (Warranty, technical service, spare parts, accessories).

Fitting the components

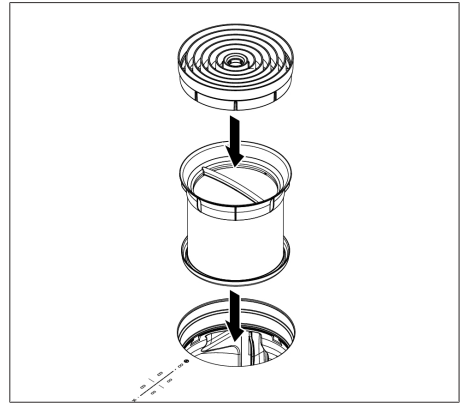

Fig. 7.2 Fitting the components

7.4.2 Removing liquids from the appliance

Any liquids that flow into the appliance through the inlet opening are caught by the stainless steel grease filter (up to 150 ml) and in the air guiding housing.

Do the following:

- ▶ Remove the air inlet nozzle and stainless steel grease filter.
- ▶ Empty the stainless steel grease filter.

- ▶ Check whether any liquid has gathered in the base of the air guiding housing.
- ▶ If necessary, wipe the liquid up from the housing base from above through the inlet opening using a sponge or cloth.
- ▶ Clean the air guiding housing.
- ▶ To dry the activated charcoal filter and duct parts, switch on the cooktop extractor at a minimum power level of 5.
- After 120 minutes the cooktop extractor will automatically switch off and the automatic after-run function will be started.

7.5 Cleaning the air guiding housing

The air guiding housing can be found on the bottom of the cooktop inside the floor unit. Grease particles and limescale residues can settle on the surface of the air guiding housing. For this reason, regular cleaning is essential.

Opening the air guiding housing

- ▶ Remove the air inlet nozzle and stainless steel grease filter.
- ▶ Remove the filter replacement cover (see figure).
- ▶ Hold the housing base with one hand.
- ▶ Release the 6 locks around the edge of the base.
- ▶ Remove the housing base.
- ▶ Clean the air guiding housing and the housing base with a mild cleaning agent.

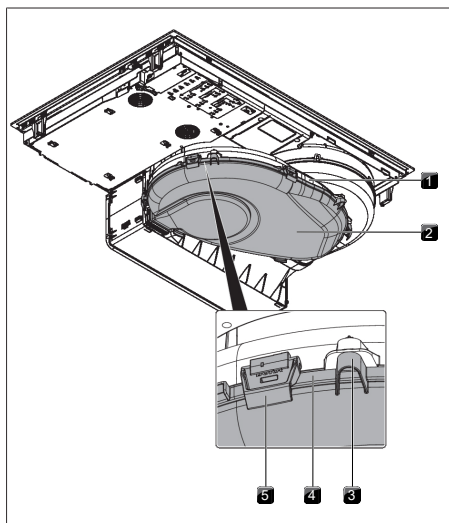

Fig. 7.3 Air guiding housing

- [1] Air guiding housing
- [2] Housing base
- [3] Spigot
- [4] Sealing groove
- [5] Lock

Closing the air guiding housing

- ▶ Position the housing base under the air guiding housing with the help of the 3 spigots.
- ▶ Push the housing base upwards into the sealing groove.
- ▶ Close the 6 locks.
- ▶ Check that the housing base is positioned correctly.
- ▶ Insert the filter replacement cover (see figure).
- ▶ Check that the filter replacement cover is positioned correctly.
- ▶ Insert the stainless steel grease filter and the air inlet nozzle.

7.6 Replace the activated charcoal filter

An activated charcoal filter will only be fitted with the stainless steel grease filter if the cooktop extractor is used in recirculation mode. The activated charcoal filter absorbs cooking odours that arise during cooking.

- i** The activated charcoal filter must be replaced when the fan indicator is shown \bar{F} (filter service display). You can obtain activated charcoal filters from your specialist supplier or from the BORA Shop via the website at <http://www.mybora.com>.

Removing the activated charcoal filter

- ▶ Remove the air inlet nozzle and stainless steel grease filter.
- ▶ Inside the inlet opening pull the filter replacement cover out through the opening in the filter housing.

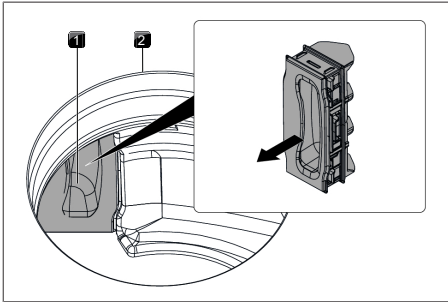

Fig. 7.4 Removing the filter replacement cover

- [1] Filter replacement cover
[2] Inlet opening

- ▶ Take hold of the activated charcoal filter by the grip strap and pull it out as far as possible through the filter housing opening.
- ▶ Take hold of the end of the activated charcoal filter and pull upwards and towards the left until it is completely out of the inlet opening.

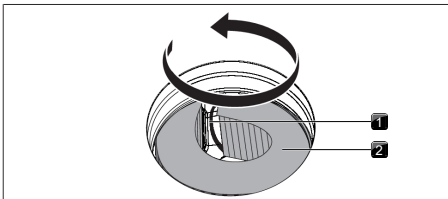

Fig. 7.5 Turning the activated charcoal filter from the filter housing

- [1] Grip strap
[2] Activated charcoal filter

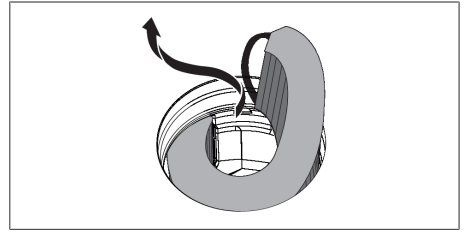

Fig. 7.6 Removing the activated charcoal filter through the inlet opening

Inserting the activated charcoal filter

- ▶ Remove the packaging from the activated charcoal filter.
- ▶ Position the activated charcoal filter correctly with the help of the printed symbols (arrow left, grip strap right).
- ▶ Hold the activated charcoal filter at both ends.
- ▶ Bend the activated charcoal filter into a cylindrical shape so that both ends of the filter are opposite each other.

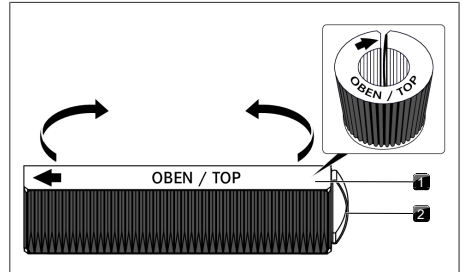

Fig. 7.7 Activated charcoal filter

- [1] Activated charcoal filter
[2] Grip strap

- ▶ Tilt the activated charcoal filter slightly and insert it through the inlet opening.

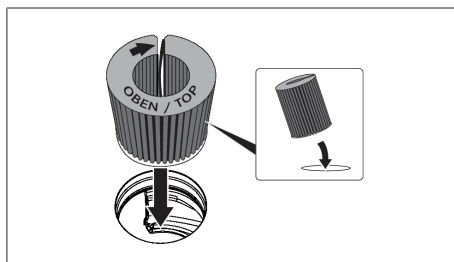

Fig. 7.8 Inserting the activated charcoal filter through the vent opening

- ▶ Guide the left end of the filter into the opening in the filter housing.
- ▶ Push the activated charcoal filter into the filter housing until it will go no further (to do this, you can place one finger between the slats and gradually push the filter into the housing).
- The end position of the activated charcoal filter is reached when the filter has been fully pushed inside the filter housing.

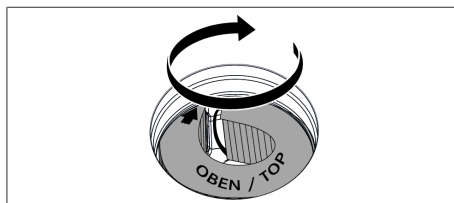

Fig. 7.9 Placing the activated charcoal filter in the end position

- ▶ Inside the inlet opening push the filter replacement cover until it comes to a stop in the filter housing opening.
- ▶ Check that the filter replacement cover is positioned correctly.

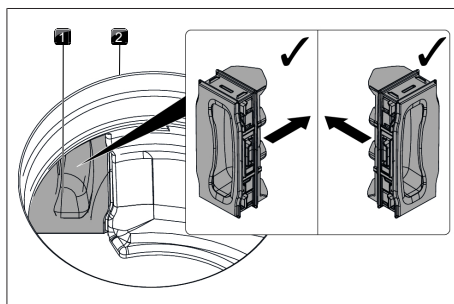

Fig. 7.10 Inserting the filter replacement cover



- [1] Filter replacement cover
- [2] Inlet opening

- ▶ Insert the stainless steel grease filter and the air inlet nozzle.
- ▶ Reset the filter service display (see "6.3 Menu item 3: Show filter status and reset filter service display").

8 Troubleshooting

i You can often remedy faults and errors yourself. This saves time and money as you don't need to call out customer services.

► Observe all safety and warning information (see "2 Safety").

Operating situation	Cause	Remedy
Appliance cannot be switched on	Fuse/automatic circuit breaker defective	Replace the fuse; Switch the automatic circuit breaker back on
	The fuse/automatic circuit breaker trips several times	BORA Contact the Service Team.
	The power supply is disconnected	Have a specialist electrician inspect the power supply
Odour formation when operating a new appliance	This is normal with brand new appliances	Odours stop forming after a few operating hours
A cooking zone display shows 	No or unsuitable cookware	Use suitable, appropriately sized cookware (see "Appliance description")
The lock button lights up 	Active child lock	deactivate the child lock
Cooking zone/cooktop switches off automatically	The maximum cooking zone operating time has been exceeded	Put the cooking zone back into operation
Power setting prematurely cancelled	The overheating protection has tripped	see "5.7.6 Overheating protection"
The cooktop cooling fan continues to run when the cooktop has been switched off	The cooling fan runs until the cooktop has cooled	Wait until the cooling fan switches off automatically
Decreased extraction performance of the cooktop extractor	Grease filter extremely dirty	Clean or replace the grease filter
	Activated charcoal filter extremely dirty (recirculation only)	Replace the activated charcoal filter
	Item in air guiding housing (e.g. cleaning cloth)	Remove the object
E or EB is displayed	Use of a phase-separating window contact switch	Open the window
	Fan defective or a duct connection has become loose	BORA Contact the Service Team
E2 is displayed	The overheating protection has tripped	see "5.7.6 Overheating protection"
E03 is displayed	Object on the operating panel	Remove the object from the operating panel
	The operating panel is dirty	Clean the operating panel
F is shown (recirculation only)	End of activated charcoal filter service life reached	Insert a new activated charcoal filter (see "7.6 Replace the activated charcoal filter").

Tab. 8.1 Troubleshooting

Faults and errors not covered:

- Switch off the appliance.
- Contact the BORA Service Team Team (see see "11 Warranty, technical service, spare parts, accessories") and enter the error number displayed and the appliance type.

9 Installation

- ▶ Observe all safety and warning information (see "2 Safety").

9.1 General installation instructions

- i** The power supply cable must be provided by the customer.
- i** The appliance must not be installed above cooling devices, dishwashers, stoves, ovens, washing machines or dryers.
- i** The contact surfaces of the worktops and wall sealing strips must be made of a heat-resistant material (up to approx. 100 °C).
- i** Worktop cut-outs must be moisture-sealed using suitable means and, where necessary, fitted with a thermal insulator.
- i** The integrated cooktop extractor must not be used with other cooktops.

General installation instructions for cooktops

- ▶ Make sure that the area below the cooktop has a sufficient air supply.
- i** To maintain the level of performance, sufficient ventilation below cooktops must be ensured.
- i** The performance is affected or the cooktops overheat if the warm air beneath the cooktops cannot escape.
- i** In the event of overheating, the cooktop power is reduced or the appliance is switched off completely.
- i** If cable protection (false floor) is planned beneath the appliance, this must be fitted so it does not obstruct ventilation.

9.1.1 Simultaneous operation of the cooktop extractor in the exhaust air mode with a fireplace dependent upon the air supply in the room

Fireplaces that depend on the air in the room (e.g. gas, oil, wood or coal-fired heaters, continuous-flow water heaters, instantaneous water heaters) draw in air from the room in which they are installed and release the exhaust fumes into the outside air via an exhaust system (e.g. chimney).

If the cooktop extractor is used in exhaust air mode, it draws in air from the room in which it is installed as well as from neighbouring rooms. Without sufficient air, there will be a drop in air pressure. Toxic gases could be drawn out of the chimney or extraction ducting and back into the room.

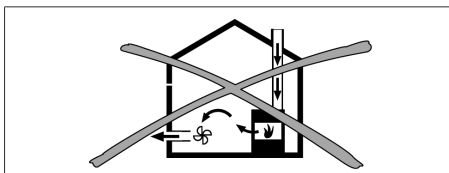

Fig. 9.1 Exhaust air installation - not permitted

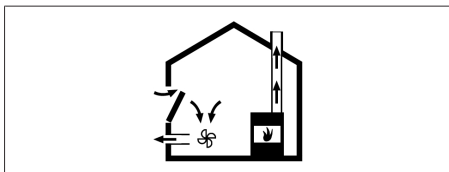

Fig. 9.2 Exhaust air installation - correct

- ▶ If simultaneously operating both the cooktop with a fireplace and the cooktop extractor in the room they are installed, ensure that...
 - ...the maximum low pressure is 4 Pa;
 - ...a safety device (e.g. window contact switch, low pressure warning device) is used to ensure that a sufficient supply of fresh air is guaranteed;
 - ...the exhaust air is not channelled into a chimney that is used for exhaust gases of appliances operated with gas or other combustibles;
 - ...the installation is checked and approved by an authorised certified engineer (e.g. heating engineer).

- i** If the cooktop extractor is used exclusively in recirculation mode, simultaneous operation with a fireplace dependent on the air in the room is possible without any additional safety measures.

9.2 Scope of delivery

Scope of delivery	Quantity
Cooktop with integrated cooktop extractor	1
Air inlet nozzle	1
Stainless steel grease filter	1
Operating and installation instructions	1
Installation clamps	4
Sealing tape	1
Height adjustment plate set	1
Bag containing various small parts for assembly	1
Additional scope of delivery PURMU	
Activated charcoal filter	1
Template for back panel cut-out	1

Tab. 9.1 Scope of delivery

Checking the scope of delivery

- ▶ Make sure the delivery is complete and check it for damage.
- ▶ Immediately notify the BORA Service Team if parts are missing or damaged.
- ▶ Do not under any circumstances install parts which are damaged.
- ▶ Dispose of transport packaging in the proper manner (see "10 Decommissioning, disassembly and disposal").

9.3 Tools and aids

The following tool, among others, is required to correctly install the appliance:

- Jigsaw or handsaw
- size 20 Torx screwdriver key
- black, heat-resistant silicone sealant
- Template for cut-out on back panel (recirculation only, included in scope of delivery)

9.4 Assembly instructions

9.4.1 Installation clearances

- ▶ Observe the required clearance around the worktop cut-out.

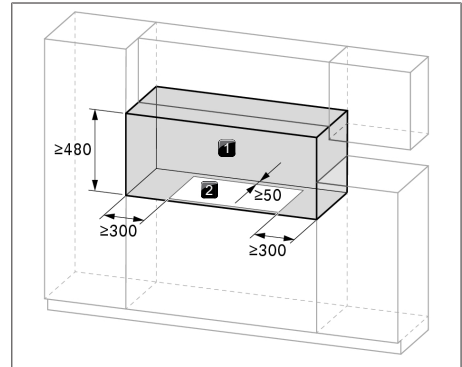

Fig. 9.3 Required clearance

- [1] Required clearance
[2] Worktop cut-out

9.4.2 Minimum unit dimensions

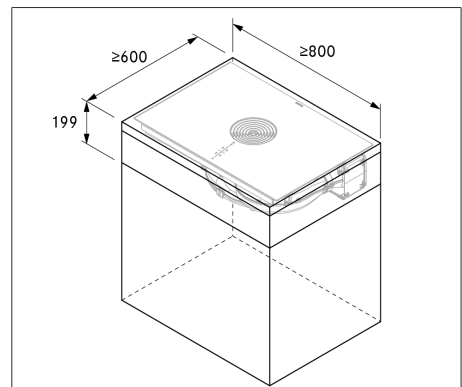

Fig. 9.4 Minimum unit dimensions for M Pure

9.4.3 Information on kitchen units

- Cross bars on the kitchen unit in the area of the worktop cut-out may need to be removed.
- In the case of thin worktops, there must be a sufficiently rigid support plate on the unit.
- The drawers and/or shelves in the floor unit must be removable.
- The drawers of the floor unit must be shortened depending on the installation situation.

If false floor (cable protection) is planned, the following must be taken into account:

- It must be fitted in such a way that it can be removed from below for maintenance work.
- To ensure sufficient cooktop ventilation, a minimum distance of 15 mm to the bottom edge of the cooktop is to be observed.

9.5 Worktop cut-out

i The minimum measurement of 50 mm from the front edge of the worktop to the worktop cut-out is a recommendation from BORA.

- ▶ Create the worktop cut-out taking into account the specified cut-out dimensions.
- ▶ Make sure that the cut surfaces of the worktops are properly sealed.
- ▶ Comply with the instructions of the worktop manufacturer.

9.5.1 Cut-out dimensions

Flush installation

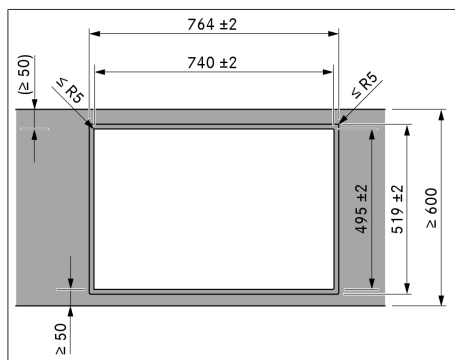

Fig. 9.5 Cut-out dimensions for flush installation

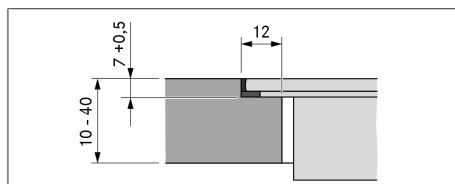

Fig. 9.6 Rebate dimensions for flush installation

Surface mounting

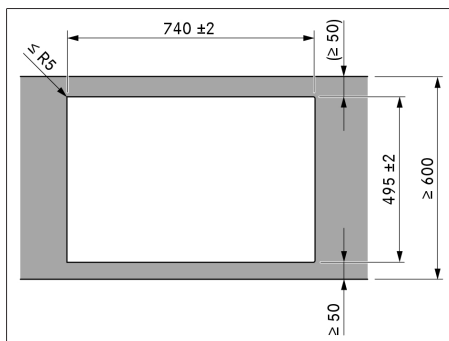

Fig. 9.7 Cut-out dimensions for surface mounting

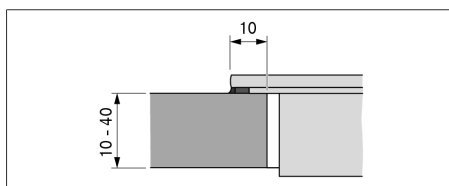

Fig. 9.8 Overlay dimensions for surface mounting

9.6 Installing the appliance in exhaust air mode

- i** National and regional laws and regulations must be observed with regard to the exhaust duct design.
- i** A sufficient air supply must be ensured.
- i** The exhaust air must be directed to the outside by appropriate exhaust air ducts.
- i** The minimum cross section of the exhaust air duct must be 176 mm^2 which equates to a round pipe with a diameter of 150 mm or the BORA Ecotube duct system.
- i** As a general rule, with the built-in fan, a length of duct of up to 6 metres with six 90° bends, 8 metres with four 90° bends or 10 metres with two 90° bends can be installed.
- i** Not compatible with BORA Universal fans.
- i** Planning instructions for the installation of the exhaust air ducts are provided in the BORA planning guide.

9.6.1 Preparing kitchen units for the exhaust air model

- The back panel of the floor unit must be adapted for the exhaust air duct.
- A minimum clearance of 120 mm between the back panel of the unit and an adjacent kitchen unit or room wall must be kept for the air duct.
- No false floor is necessary below the cooktop.

Adjusting the back panel of the unit

- ▶ Before installation, check the suitability of the floor unit with regard to the necessary installation dimensions for the appliance and the planned duct system.
- ▶ If necessary, adjust the position of the back panel according to the required installation dimensions.

9.6.2 Installation dimensions

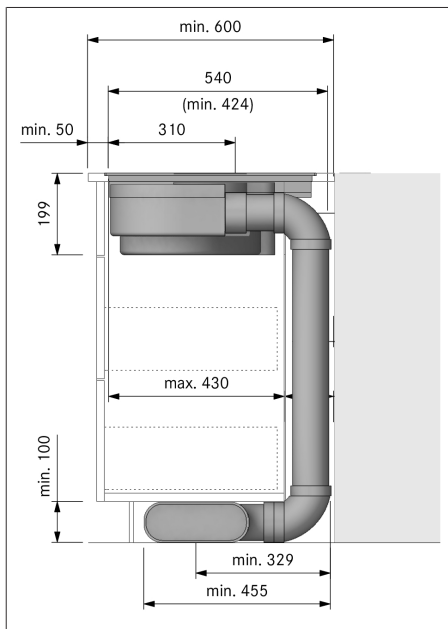

Fig. 9.9 Installation dimensions for exhaust air, worktop depth 600 mm

9.6.3 Preparing the appliance

Attaching the sealing tape

- ▶ In the case of surface mounting, attach the enclosed sealing tape around the outer edges of the underside of the cooktop. Do not leave any gaps.

- ▶ In the case of flush installation, attach the sealing tape to the contact surfaces in the worktop cut-out, even if you are sealing the cooktop with a silicone sealing compound or similar.

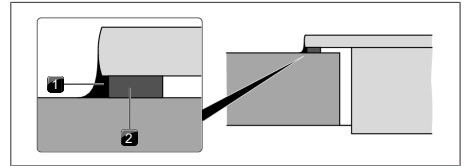

Fig. 9.10 Sealing tape in the case of surface mounting

- [1] Black, heat-resistant silicone sealant
- [2] Sealing tape

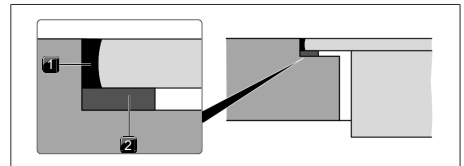

Fig. 9.11 Sealing tape in the case of flush installation

- [1] Black, heat-resistant silicone sealant
- [2] Sealing tape

Fitting the installation clamps

- ▶ Push 2 installation clamps onto each side of the cooktop until they come to a stop in the retaining brackets provided.

- i** 2 installation clamps must be fitted to each side of the cooktop.

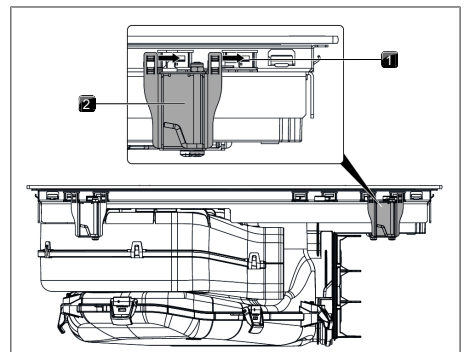

Fig. 9.12 Fitting the installation clamps

- [1] Retaining brackets
- [2] Installation clamps

9.6.4 Inserting the cooktop

- ▶ Before inserting the cooktop, remove the air inlet nozzle and the stainless steel grease filter.
- ▶ Use the inlet opening as a handle during insertion.
- ▶ Keep the cooktop straight as you lift it into the worktop cut-out.
- ▶ Insert the cooktop into the centre of the worktop cut-out.
- ▶ Precisely align the cooktop.

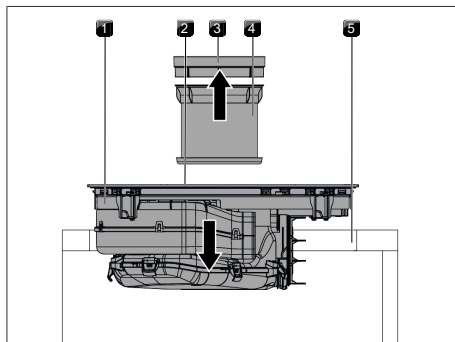

Fig. 9.13 Positioning the cooktop in the centre

- [1] Cooktop
- [2] Inlet opening
- [3] Air inlet nozzle
- [4] Stainless steel grease filter
- [5] Worktop cut-out

- i** Make sure that the cooktop sealing tape is flat against the worktop in the case of surface mounting.
- i** Make sure that the cooktop sealing tape is well sealed all the way round in the case of flush installation.

Height adjustment plates for flush installation (optional)

- The height adjustment plates are self-adhesive to prevent slipping during installation.
- ▶ If applicable, insert the height adjustment plates.
- ▶ Place the height adjustment plates next to the sealing tape.

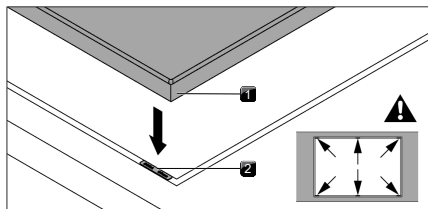

Fig. 9.14 Positioning the height adjustment plates

- [1] Cooktop
- [2] Height adjustment plate

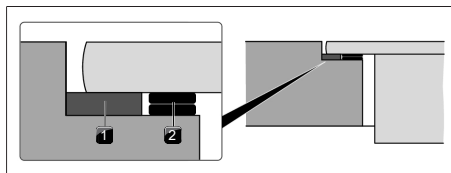

Fig. 9.15 Height adjustment plates

- [1] Sealing tape
- [2] Height adjustment plate

9.6.5 Securing the cooktop

- ▶ Secure the cooktop to the worktop with the fixing bracket on the installation clamp.
- ▶ Tightening torque: max. 2.2 Nm.

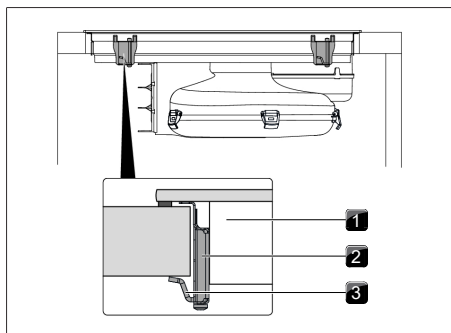

Fig. 9.16 Securing the cooktop in the middle

- [1] Cooktop
- [2] Mounting bracket
- [3] Fixing bracket

9.6.6 Connecting the appliance to the duct system

- i** The duct system must be fitted to the appliance free of load and with the power supply switched off.
- i** When attaching the seals, ensure that an airtight seal is created with the connecting duct piece when the seals are compressed.
- ▶ Use only BORA Ecotube duct parts.
- ▶ Do not use flexible or fabric hoses.

- ▶ Pull the seal onto the exhaust opening on the appliance. The seal will need to be stretched slightly.
- ▶ Push the duct part to be connected with the coupling onto the exhaust opening with the seal.
- ▶ Ensure that the seal is not displaced.

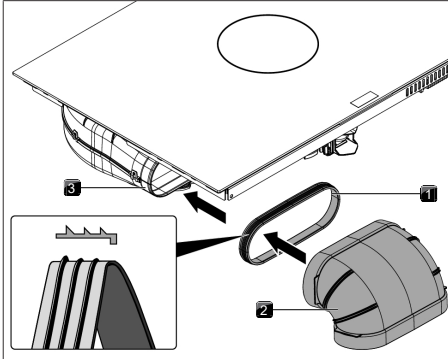

Fig. 9.17 Connecting the duct system

- [1] Seal
- [2] Duct part
- [3] Exhaust opening

9.7 Installing the appliance in recirculation mode

9.7.1 Recirculation of air from the kitchen unit

In the case of recirculation systems, a return flow aperture must be provided in the kitchen unit to guide the clean recirculated air out of the unit and back into the room. The return flow aperture can be created above a shortened plinth. A slatted plinth with at least the minimum opening cross-section can also be used.

- ▶ Decrease the height of the plinth panel or create corresponding openings in the plinth.
- ▶ The cross-section of the return flow aperture must be $\geq 500 \text{ cm}^2$ for each cooktop extractor.

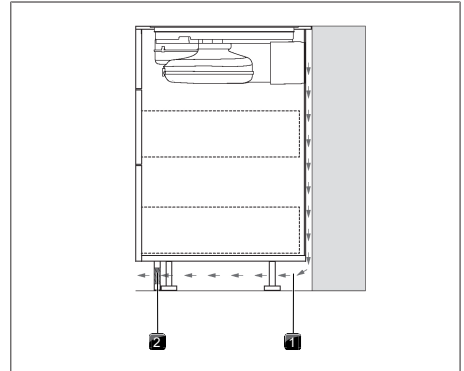

Fig. 9.18 Return flow aperture in the plinth area

- [1] Return flow aperture in the plinth (total cross-section of the aperture $\geq 500 \text{ cm}^2$)
- [2] Return flow of recirculated air

9.7.2 Installation variants (A and B) for recirculation appliances

There are 2 installation variants for recirculation appliances:

A: floor unit with continuous back panel

The recirculated air is guided through the connection with the back wall of the air purification box directly behind the back panel of the unit. The recirculated air goes back in to the room through the return flow aperture.

For installation purposes, this means that:

- No false floor is necessary below the cooktop.
- There must be a cut-out in the back panel.

B: floor unit with false floor under the cooktop

The recirculated air is blown into the free space between the worktop and the false floor (the air purification box does not connect with the back panel). The recirculated air goes behind the back panel of the unit and through the return flow aperture back into the room.

For installation purposes, this means that:

- a false floor is necessary below the cooktop.
- There does not need to be a cut-out in the back panel of the unit.

9.7.3 Preparing the kitchen unit for installation variant A

- The floor unit must have a continuous back panel so that the recirculated air is not directed into the front furniture body compartment.
- There must be a cut-out in the back panel.
- A minimum clearance of 25 mm between the back panel of the unit and an adjacent kitchen unit or room wall must be kept for the return flow aperture.
- No false floor is necessary below the cooktop.

Adjusting the back panel of the unit

- ▶ Adapt the back panel according to the required installation dimensions.
- ▶ If necessary, move the back panel.
- ▶ If necessary, extend the height of the back panel so that the unit is closed to the front.

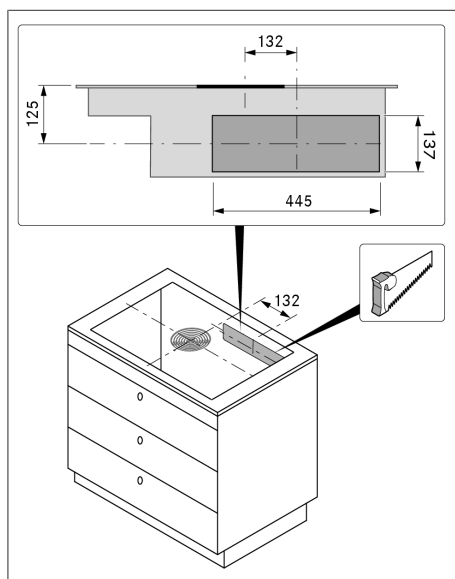

Fig. 9.19 Back panel cut-out

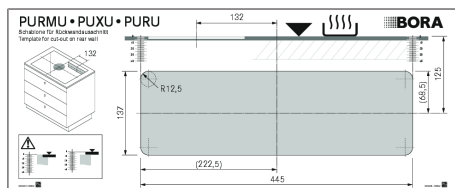

Fig. 9.20 Template for back panel cut-out

- ▶ Position the template on the back panel of the unit with the help of the markings and instructions.
- ▶ Mark out the back panel cut-out.
- ▶ Cut out the back panel cut-out with a saw.

- i** Flush and surface mounting options must be taken into account when positioning the template. 125 mm from top edge of the cooktop to centre of cut-out.

9.7.4 Installation dimensions for installation variant A

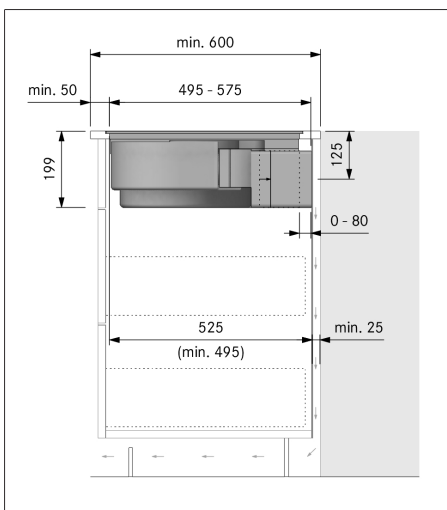

Fig. 9.21 Installation dimensions in the case of recirculated air, installation variant A

9.7.5 Preparing the kitchen unit for installation variant B

- A false floor must be provided for under the cooktop.
- The back panel of the unit must be flush with the false floor so that the recirculating air is not directed into the front of the unit.
- A minimum clearance of 25 mm between the back panel of the unit and an adjacent kitchen unit or room wall must be kept for the return flow aperture.

Adjusting the back panel of the unit

- ▶ Adapt the back panel according to the required installation dimensions.
- ▶ If necessary, move the back panel.

- ▶ Adjust the height of the back panel to the false floor so that they are flush with one another.

9.7.6 Installation dimensions for installation variant B

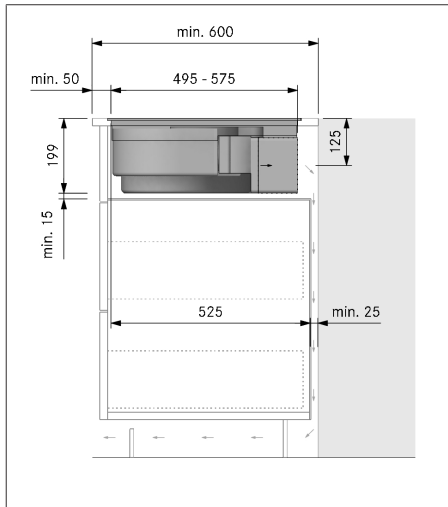

Fig. 9.22 Installation dimensions for recirculation installation variant B, depth of worktop 600 mm

9.7.7 Preparing the appliance

Attaching the sealing tape

- ▶ In the case of surface mounting, attach the enclosed sealing tape around the outer edges of the underside of the cooktop. Do not leave any gaps.
- ▶ In the case of flush installation, attach the sealing tape to the contact surfaces in the worktop cut-out, even if you are sealing the cooktop with a silicone sealing compound or similar.

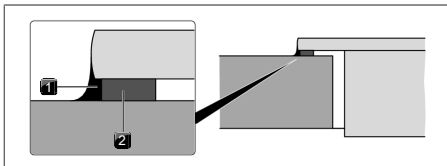

Fig. 9.23 Sealing tape in the case of surface mounting

- [1] Black, heat-resistant silicone sealant
- [2] Sealing tape

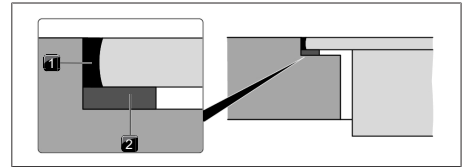

Fig. 9.24 Sealing tape in the case of flush installation

- [1] Black, heat-resistant silicone sealant
- [2] Sealing tape

Fitting the installation clamps

- ▶ Push 2 installation clamps onto each side of the cooktop until they come to a stop in the retaining brackets provided.

- i** 2 installation clamps must be fitted to each side of the cooktop.

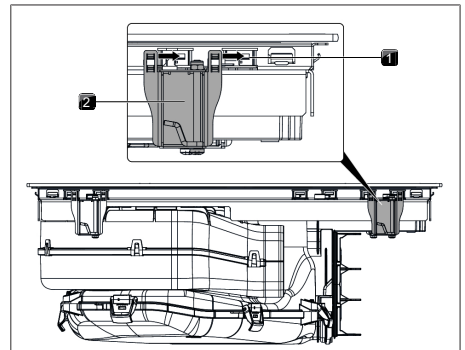

Fig. 9.25 Fitting the installation clamps

- [1] Retaining brackets
- [2] Installation clamps

9.7.8 Extending the telescopic pull-out of the air purification box

If the depth of the worktop exceeds 675 mm in installation variant A, the telescopic pull-out of the air purification box must be extended using the accessory PULBTA.

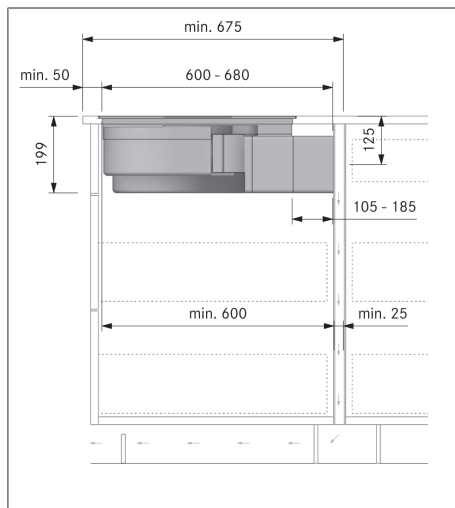

Fig. 9.26 Installation dimensions for recirculation installation variant A, depth of worktop 675 mm and over

i The telescopic pull-out is used to connect the duct to the back panel of the kitchen unit. This can be used to flexibly bridge the gap between the cooktop and the back panel of the kitchen unit (max. 80 mm). If necessary, the telescopic pull-out can be extended by a further 105 mm using the extension PULBTA (available as an accessory).

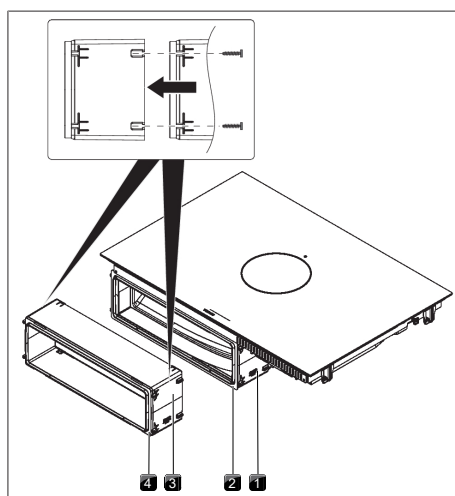

Fig. 9.27 Extending the telescopic pull-out

- [1] Air purification box with telescopic pull-out
- [2] Telescopic pull-out adhesive tape
- [3] Telescopic pull-out extension PULBTA
- [4] Adhesive tape for telescopic pull-out extension PULBTA

- ▶ Remove the protective film from the adhesive tape on the front of the telescopic pull-out.
- ▶ Attach the extension PULBTA (available as an accessory including screws for attachment) to the telescopic pull-out.
- ▶ Remove the protective film from the adhesive tape on the front of the extension PULBTA.

9.7.9 Inserting the cooktop – recirculation

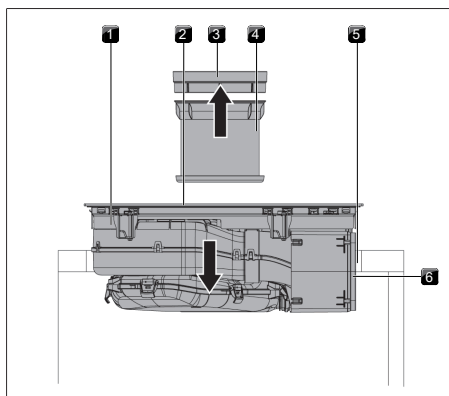

Fig. 9.28 Positioning the cooktop in the centre

- [1] Cooktop
- [2] Inlet opening
- [3] Air inlet nozzle
- [4] Stainless steel grease filter
- [5] Worktop cut-out
- [6] Adhesive tape

- ▶ Before inserting the cooktop, remove the air inlet nozzle and the stainless steel grease filter.
- ▶ Remove the protective film from the adhesive tape on the front of the telescopic pull-out.
- ▶ Use the inlet opening as a handle during insertion.
- ▶ Keep the cooktop straight as you lift it into the worktop cut-out.
- ▶ Insert the cooktop into the centre of the worktop cut-out.
- ▶ Precisely align the cooktop.

- i** Make sure that the cooktop sealing tape is flat against the worktop in the case of surface mounting.
- i** Make sure that the cooktop sealing tape is well sealed all the way round in the case of flush installation.

Height adjustment plates for flush installation (optional)

- The height adjustment plates are self-adhesive to prevent slipping during installation.
- ▶ If applicable, insert the height adjustment plates.
- ▶ Place the height adjustment plates next to the sealing tape.

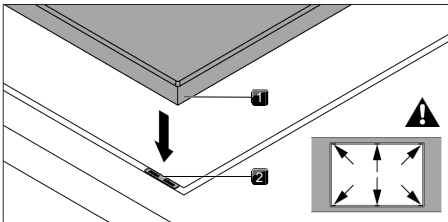

Fig. 9.29 Positioning the height adjustment plates

- [1] Cooktop
- [2] Height adjustment plate

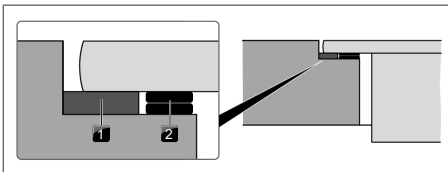

Fig. 9.30 Height adjustment plates

- [1] Sealing tape
- [2] Height adjustment plate

9.7.10 Securing the cooktop

- ▶ Secure the cooktop to the worktop with the fixing bracket on the installation clamp.
- ▶ Tightening torque: max. 2.2 Nm.

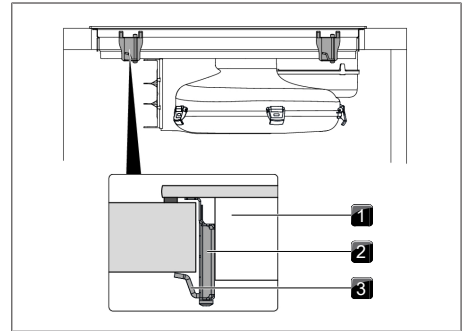

Fig. 9.31 Securing the cooktop in the middle

- [1] Cooktop
- [2] Mounting bracket
- [3] Fixing bracket

9.7.11 Making a connection with the back panel in installation variant A

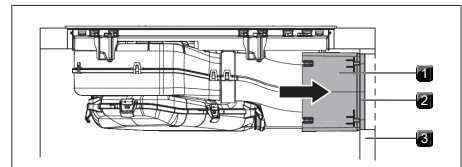

Fig. 9.32 Connection with the back panel

- [1] Telescopic pull-out
- [2] Adhesive tape
- [3] Back panel of unit

- ▶ Push the telescopic pull-out until it is tight up against the back panel of the unit.
- With the telescopic pull-out the distance to the back panel of the unit can be flexibly bridged.
- ▶ Check that the telescopic pull-out fits accurately, is flush with the cut-out on the back panel of the unit and closes it off.
- ▶ Secure the telescopic pull-out to the back panel of the unit using the adhesive tape.

9.7.12 Inserting the activated charcoal filter

- i** See chapter Cleaning and maintenance, “7.6 Replacing the activated charcoal filter”

9.8 Connecting the power supply

► Observe all safety and warning information (see "2 Safety").

i Assembly, installation and commissioning must always occur in line with national laws, regulations and standards. The work must be performed by qualified specialists who know and comply with the additional regulations of the local energy supply companies.

i Connections via plug-in contacts (Schuko plugs) are not permitted.

i 1-phase connection. The appliance complies with the requirements of IEC 61000-3-12.

► Switch off the main switch/automatic circuit breaker before connecting the cooktop.

► Secure the main switch/automatic circuit breaker against being switched back on without permission.

► Make sure the power to the appliance is disconnected.

► Connect the cooktop exclusively via a fixed connection to an H 05 VV-F power supply cable with corresponding minimum cross-section.

Connection	Fuse protection	Minimum cross-section
Three-phase connection	3 x 16 A	2.5 mm ²
Two-phase connection	2 x 16 A	2.5 mm ²
One-phase connection	1 x 32 A	4 mm ²

Tab. 9.2 Fuse protection and minimum cross-section

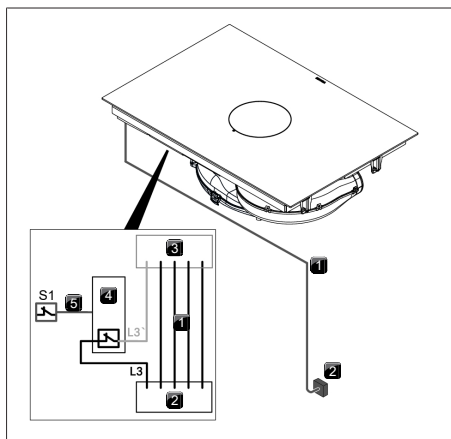

Fig. 9.33 Connection diagram with external switch contact

[1] Cooktop and cooktop extractor power supply cable

[2] Power supply

[3] Cooktop and cooktop extractor power supply

[4] Switch relay

[5] Switch connection S1 and switch relay

[S1] External switch contact

► Connect the mains supply cable to the power supply of the appliance in accordance with the relevant connection diagram (see figures or underside of appliance).

► For a single-phase or two-phase connection, connect the relevant contacts using the bridge provided (in scope of delivery).

► Secure the connection cable with the strain relief clamp (in scope of delivery).

► Close the power supply housing with the power supply cover (in scope of delivery).

► Lay the connection cable along the mounting eyes with the help of the cable ties (in scope of delivery).

► Ensure that the cable is not trapped or damaged and is not able to come into contact with any hot areas on the cooktop.

► Check that installation has been carried out correctly.

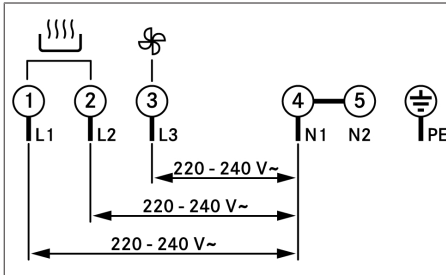

Fig. 9.34 Connection diagram for 3-phase connection

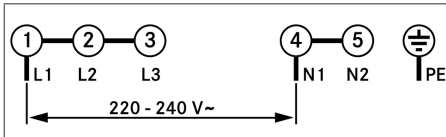

Fig. 9.35 Connection diagram for 1-phase connection

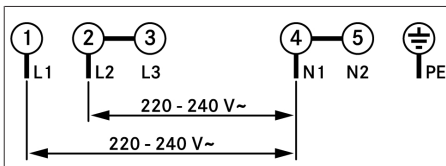

Fig. 9.36 Connection diagram for 2-phase connection

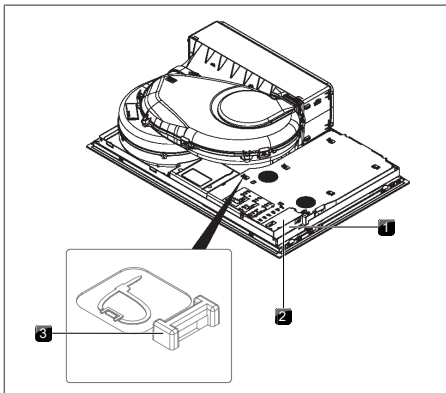

Fig. 9.37 Electrical connections of the cooktop

- [1] Power supply
- [2] Power supply cover
- [3] Mounting eyes

9.9 Initial operation

- i** During initial operation some basic settings (basic configuration) must be applied using the dealer and service menu.

9.9.1 Dealer and service menu

- i** The dealer and service menu can be called up up to 2 minutes after the appliance has been connected to the power supply.
- i** The system adopts and saves the settings made when you exit the corresponding menu item.
- i** Below you will find explanations on how to use the menu and a description of the most important menu items.

Dealer and service menu overview

Menu item/Description/ Selection area	Factory setting
B Extraction system (exhaust air/recirculation system)	Recirculation
C Power management	
D Demo mode	Off

Tab. 9.3 Menu overview

Calling up the dealer and service menu

- ▶ Connect the appliance to the power supply.
 - The standard display appears and the fan symbol pulses for 2 minutes.
- ▶ Long press on the fan button
- 4 input points are shown.
- ▶ Keep the fan button pressed and at the same time press the input points in the specified order.
 - Menu item B is displayed.

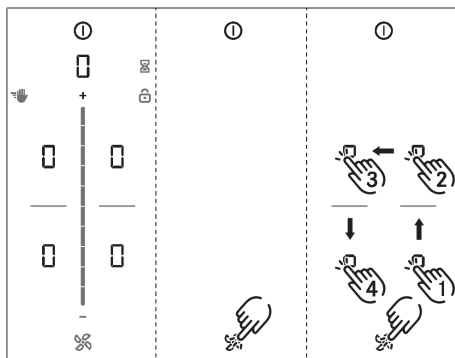

Fig. 9.38 Calling up the dealer and service menu

9.9.2 Menu item B: Extraction system configuration

The extraction system must be configured.

There are two operating modes to choose from:

- Operating mode 1: recirculation system (factory setting)
 - Operating mode 2: exhaust air system
- ▶ Select the corresponding operating mode (tap the corresponding segment on the slider).
- ▶ Confirm and save the setting by moving to the next menu item (tap the multi-function display/indicator b).

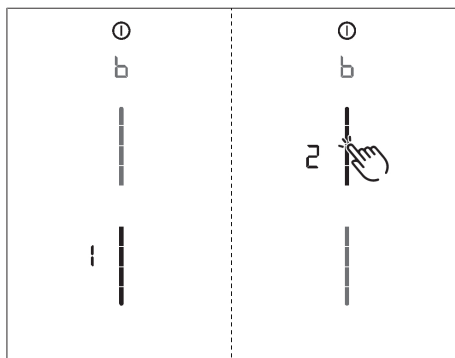

Fig. 9.39 Display Menu item B: Configuring the extraction system

9.9.3 Menu item C: Power management

The total appliance power can be reduced if the required electrical power cannot be provided at the installation site.

There are three operating modes to choose from:

Power management	Connection	Maximum power consumption	Fuse protection
C3	three-phase	7600 W	3 x 16 A
C3	two-phase	7600 W	2 x 16 A
C3	single-phase	7600 W	1 x 32 A
C2	single-phase	4400 W	1 x 20 A
C1	single-phase	3600 W	1 x 16 A

Tab. 9.4 Power management

- ▶ Select the corresponding operating mode (tap the corresponding segment on the slider).
- ▶ Confirm and save the setting by moving to the next menu item (tap the multi-function display/indicator c).

i The cooking zone power restrictions automatically implemented by the appliance are determined according to the total power set.

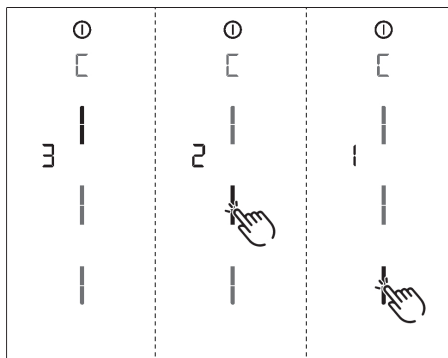





Fig. 9.40 Display menu item C: Power management

9.9.4 Menu item D: Demo mode

The appliance can be set to demo mode, which includes all operating functions, but the heating function of the cooktops is deactivated.

- ▶ Tap the top slider segment.

- The demo mode symbol  is displayed on all cooking zones for one second.
-  is displayed.
- ▶ Confirm and save the setting by moving to the next menu item (tap the multi-function display/indicator .

Closing the dealer and service menu

When you have been through all of the basic configuration menu items:

- ▶ long press on the multi-function display.
- ▶ The standard display appears.

-  Pan size recognition is deactivated in demo mode.

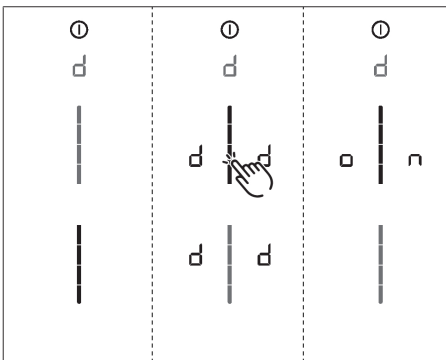

Fig. 9.41 Display Menu item D: Demo mode

9.9.5 Function test

- ▶ Carry out a thorough function test on all appliances.
- ▶ In the event of error messages, see the “Troubleshooting” chapter.

9.10 Sealing the appliance

- ▶ Once all of the installation work is complete, seal the appliance with black, heat-resistant silicone sealant.
- ▶ Make sure that no silicone sealant gets under the cooktop.

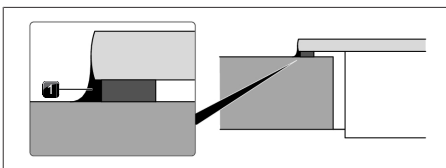

Fig. 9.42 Silicone sealant for surface mounting

- [1] Black, heat-resistant silicone sealant

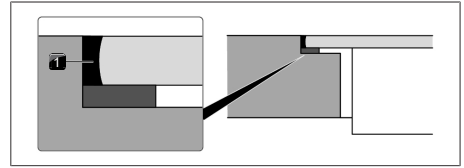

Fig. 9.43 Silicone sealant for flush installation

- [1] Black, heat-resistant silicone sealant

9.11 Handover to user

Once installation is complete:

- ▶ Explain the main functions to the user.
- ▶ Explain all safety-related aspects of operation and handling to the user.
- ▶ Provide the user with the accessories and operating and installation instructions, which are to be kept in a safe place.

10 Decommissioning, disassembly and disposal

- ▶ Observe all safety and warning information (see "2 Safety").
- ▶ Follow the enclosed manufacturer's information.

10.1 Decommissioning

Decommissioning refers to ultimate decommissioning and disassembly. Following decommissioning, the appliance can either be installed in another unit, sold on privately or disposed of.

- i** The electricity connection may only be disconnected and cut off by certified specialists.
- ▶ Switch the appliance off before decommissioning (see operating instructions)
- ▶ Disconnect the appliance from the power supply.

10.2 Disassembly

To be removed, the appliance must be accessible for disassembly and disconnected from the power supply.

- ▶ Remove the silicone seals.
- ▶ Lift the appliance up and out through the top of the worktop.
- ▶ Remove any other accessories.
- ▶ Dispose of the old appliance and any soiled accessories as described under "Environmentally-friendly disposal".

10.3 Environmentally-friendly disposal

10.3.1 Disposal of transport packaging

- i** The packaging protects the appliance from damage during transport. The packaging materials have been selected taking into account the environment and their disposal and are therefore recyclable.

Recycling the packaging saves raw materials and reduces waste. Your specialist retailer will take the packaging back.

- ▶ Give the packaging to your specialist retailer or
- ▶ dispose of the packaging correctly observing regional regulations.

10.3.2 Disposal of accessories

Dispose of unnecessary or used accessories (activated charcoal filters, etc.) accordingly taking into account the regional regulations.

10.3.3 Disposal of the old appliance



Electrical appliances with this mark must not be disposed of in the household waste at the end of their service life. They must be disposed of at a collection point for the recycling of electrical or electronic appliances. Information on this can be obtained from the city or local councils.

Waste electrical and electronic appliances often still contain valuable materials. However, they also contain harmful substances that were necessary to make them work and ensure their safety. If placed in the household waste or handled incorrectly, they may harm human health and damage the environment.

- ▶ Never dispose of your old appliance in the household waste.
- ▶ Take the appliance to a regional collection point for the return and further processing of electrical and electronic components and other materials.

11 Warranty, technical service, spare parts, accessories

- Observe all safety and warning information (see "2 Safety").

11.1 BORA manufacturer's warranty

BORA provides its end customers with a 2-year manufacturer's warranty for its products. The end customer is entitled to this warranty in addition to the statutory claims for defects against the sellers of our products.

The manufacturer's warranty applies to the BORA products listed here, which are sold by authorised BORA retailers or by BORA trained salespersons and are installed within the European Union (overseas territories excluded), Switzerland, Liechtenstein, Ukraine, Russia, Norway, Serbia, Israel, UK, Iceland, India, Australia and New Zealand, with the exception of BORA products labelled as universal or accessories:

- Cooktops
- Cooktop extractor systems
- Fans

The manufacturer's warranty starts as soon as the BORA product is handed over to the end customer and is valid for 2 years. Registering on www.mybora.com enables the manufacturer's warranty to be extended to 3 years.

The manufacturer's warranty requires expert installation (in accordance with the valid BORA planning guide and operating instructions at the time of installation) of the BORA products by an authorised BORA retailer. During use, the end customer is to adhere to the specifications and instructions in the operating manual.

When filing a warranty claim, BORA must be directly notified of the fault and the receipt must be presented. Alternatively, proof of purchase can be provided by registering on www.mybora.com.

BORA guarantees that all BORA products are free from material and production defects. The defect must exist prior to delivery of the product to the end customer.

Filing a warranty claim does not interrupt the warranty period, nor shall the period start anew.

BORA will correct defects in BORA products at its own discretion by repairing or replacing the product. All costs for the correction of defects under the manufacturer's warranty shall be assumed by BORA.

Expressly not covered by the BORA manufacturer's warranty are:

- BORA products that were not sold by authorised BORA dealers or salespersons trained by BORA
- Damage caused by non-adherence to the operating instructions (including product care and cleaning). This represents improper use.
- Damage caused by normal use, e.g. traces of usage on the cooktop
- Damage caused by external influences (such as transport damage, ingress of condensation, damage caused by the elements such as a lightning strike)
- Damage caused by repairs or repair attempts that were not carried out by BORA or by persons authorised by BORA .
- Damage to the glass ceramic
- Injury caused by electrical voltage fluctuations
- Secondary damage or claims for damages beyond the defect
- Damage to plastic parts

Legal claims, particularly statutory claims for defects or product liability are not limited by the warranty and can be asserted free of charge.

If a defect is not covered by the manufacturer's warranty, a claim may be made against the BORA Technical Service.

. BORA shall not assume the resulting costs.

The laws of the Federal Republic of Germany apply to these warranty conditions.

You can contact us at:

BORA Vertriebs GmbH & Co KG, Innstraße 1, 6342 Niederndorf, Austria

- Telephone: +800 7890 0987
Monday to Thursday from 8 a.m. to 6 p.m. and Friday from 8 a.m. to 5 p.m.
- Email: info@bora.com

11.1.1 Warranty extension

You can extend the warranty by registering at www.bora.com/registration .

11.2 Service

BORA Service:

see reverse side of operating and assembly instructions



- ▶ In the case of faults you cannot fix yourself, contact your BORA specialised retailer or the BORA Service Team appears in the cooktop extractor control knob display.

The BORA Service Team will require the type designation and serial number of your appliance (FD number).

This information is provided on the nameplate on the warranty form as well as on the bottom of the appliance.

11.3 Spare parts

- ▶ Only use original spare parts for repairs.
- ▶ Repairs may only be carried out by the BORA Service Team.

i Spare parts can be obtained from your BORA dealer, the BORA online service website at www.bora.com/service or by calling the service number provided.

11.4 Accessories

Accessories	PURMA	PURMU
Activated charcoal filter PUAKF		✓
Stainless steel grease filter PUEF	✓	✓
Air inlet nozzle black PUED	✓	✓
Air inlet nozzle greige PUEDG	✓	✓
Air inlet nozzle red PUEDR	✓	✓
Air inlet nozzle jade green PUEDJ	✓	✓
Air inlet nozzle orange PUEDO	✓	✓
Air inlet nozzle blue PUEDB	✓	✓
Side frame USL515	✓	✓
Side frame All Black USL515AB	✓	✓
Cooktop frame BKR760	✓	✓
Glass ceramic scraper UGS	✓	✓
Window contact switch UFKS	✓	
Air purification box PULB (for conversion from exhaust air to recirculation)	✓	
Grill pan for surface induction KWGPFI	✓	✓

Tab. 11.1 M Pure accessories

12 Product data sheets

12.1 PURMA - Cooktop extractor product data sheet

Product information according to Commission Delegated Regulation (EU) No. 65/2014 and Regulation (EU) No. 66/2014.

Manufacturer	BORA		
Model identification	PURMA		
	Symbol	Value	Unit
Energy consumption			
Annual energy consumption	AEC _{hood}	34,1	kWh/a
Energy efficiency class	-	A+	-
Energy efficiency index	EEI _{hood}	42,9	-
Flow volume			
Fluid dynamic efficiency	FDE _{hood}	32.9	-
Fluid dynamic efficiency class	-	A	-
Air flow at minimum speed in normal operation	-	187	m ³ /h
Air flow at maximum speed in normal operation	-	565	m ³ /h
Air flow when operated on the intensive level or fast mode level (power setting)	-	620	m ³ /h
Maximum air flow	Q _{max}	635,6	m ³ /h
Measured air flow rate at the best efficiency point	Q _{BEP}	290,0	m ³ /h
Measured air pressure at the best efficiency point	P _{BEP}	476	Pa
Measured electric power input at the best efficiency point	W _{BEP}	116,7	W
Time increase factor	f	0.8	-
Lighting			
Lighting efficiency	LE _{hood}	*	lx/W
Lighting efficiency class	-	*	-
Nominal power of the lighting system	W _L	*	W
Average illumination of the lighting system on the cooking surface	E _{middle}	*	lx
Grease filtering			
Grease filtering efficiency	GFE _{hood}	96,3	%
Grease filtering efficiency class	-	A	-
Airborne noise emission			
Sound power level at minimum available speed in normal operation	L _{WA}	42	dB re 1 pW
Sound power level at maximum available speed in normal operation	L _{WA}	67	dB re 1 pW
Sound power level when operated on the intensive level or fast mode level (power setting)	L _{WA}	69	dB re 1 pW
Sound pressure level at minimum available speed in normal operation**	L _{pA}	29	dB re 20 µPa
Sound pressure level at maximum available speed in normal operation**	L _{pA}	54	dB re 20 µPa
Sound pressure level when operating on the intensive level or fast mode level (power setting)**	L _{pA}	56	dB re 20 µPa

Manufacturer	BORA		
Model identification	PURMA		
Power consumption			
Power consumption in off mode	P _o	0.18	W
Power consumption in standby mode	P _s	*	W

Tab. 12.1 Cooktop extractor product data sheet

* Does not apply to this product.

** Voluntary declaration

12.2 M Pure - Cooktop product data sheet

Product information according to Regulation (EU) Nr. 66/2014.

Manufacturer	BORA		
Model identification	PURMA/PURMU		
Type of hob	Glass ceramic cooktop		
Number of cooking zones/cooking areas	4		
Heating technology	Induction cooking zones and cooking surfaces		
	Symbol	Value	Unit
Size of usable surface			
Front left cooking zone	∅	21.0	cm
Rear left cooking zone	∅	17.5	cm
Front right cooking area	LxW	23.0 x 23.0	cm
Rear right cooking area	LxW	23.0 x 23.0	cm
Energy consumption			
Front left cooking zone	EC _{electric cooking}	168,9	Wh/kg
Rear left cooking zone	EC _{electric cooking}	182,1	Wh/kg
Front right cooking area	EC _{electric cooking}	189,7	Wh/kg
Rear right cooking area	EC _{electric cooking}	182,7	Wh/kg
Right bridged cooking areas	EC _{electric cooking}	178,0	Wh/kg
Energy consumption of the hob	EC _{electric hob}	180,3	Wh/kg

Tab. 12.2 Cooktop product data sheet

DE Bedienungs- und Montageanleitung: Original Übersetzung**Hersteller:** BORA Vertriebs GmbH & Co KG

Weitergabe sowie Vervielfältigung dieser Unterlage, Verwertung und Mitteilung ihres Inhalts sind nicht gestattet, soweit nicht ausdrücklich zugestanden.

Bei der Erstellung dieser Bedienungs- und Montageanleitung wurde mit größter Sorgfalt gearbeitet. Dennoch kann es passieren, dass nachträgliche technische Änderungen noch nicht ergänzt bzw. entsprechende Inhalte noch nicht angepasst wurden. Wir bitten dies zu entschuldigen. Eine aktualisierte Version kann über das BORA Service Team angefordert werden. Druckfehler und Irrtümer vorbehalten.

© BORA Vertriebs GmbH & Co KG

Alle Rechte vorbehalten.

EN Operating and installation instructions: Original Translation**Manufacturer:** BORA Vertriebs GmbH & Co KG

The distribution and duplication of this document, as well as the use and disclosure of its contents are prohibited unless expressly authorised.

Great care was taken when devising these operating and installation instructions. However, it may be the case that later technical changes have not yet been added or the corresponding contents have not yet been modified. We apologise for this. An up-to-date version can be requested from the BORA Service team. Misprints and errors excepted.

© BORA Vertriebs GmbH & Co KG

All rights reserved.

ES Instrucciones de uso y montaje: Original Traducción**Fabricante:** BORA Vertriebs GmbH & Co KG

Queda prohibida la transmisión y la reproducción de esta documentación, así como el uso y divulgación de su contenido sin autorización expresa.

El presente manual de instrucciones de uso y montaje se ha elaborado con la máxima atención y cuidado. No obstante, puede ocurrir que no haya sido completado o que sus contenidos no se hayan adaptado tras modificaciones técnicas posteriores. Le rogamos disculpas en este caso. Puede solicitar una versión actualizada al equipo de BORA Service. Errores tipográficos y de imprenta reservados.

© BORA Vertriebs GmbH & Co KG

Todos los derechos reservados.

FR Notice d'utilisation et de montage: Original Traduction**Fabricant:** BORA Vertriebs GmbH & Co KG

Toute communication et reproduction de ce document, toute exploitation et communication de son contenu sont interdites, sauf autorisation expresse.

L'élaboration de la présente notice d'utilisation et de montage a été réalisée avec le plus grand soin. Il se peut pourtant que certaines modifications techniques n'aient pas encore été mises en œuvre et que le contenu n'ait par conséquent pas encore été adapté. Nous vous prions de bien vouloir nous en excuser. Une version à jour peut être obtenue auprès de l'équipe du service technique de BORA. Sous réserve d'erreurs de contenu ou d'impression.

© BORA Vertriebs GmbH & Co KG

Tous droits réservés.

IT Istruzioni per l'uso e il montaggio: Originale Traduzione**Produttore:** BORA Vertriebs GmbH & Co KG

Se non espressamente consentito, non sono ammesse la comunicazione e la duplicazione dei presenti allegati, così come il riutilizzo e la diffusione dei loro contenuti.

Nella stesura delle presenti Istruzioni per l'uso e il montaggio è stata applicata la massima cura. Tuttavia è possibile che modifiche tecniche ovvero che determinati contenuti non siano ancora stati adeguati. Chiediamo la vostra comprensione in merito. Una versione aggiornata può essere richiesta tramite il team di assistenza BORA. Con riserva di errori di stampa e altri errori.

© BORA Vertriebs GmbH & Co KG

Tutti i diritti riservati.



005311-10001



BORA Lüftungstechnik GmbH

Rosenheimer Str. 33
83064 Raubling
Deutschland
T +49 (0) 8035 / 9840-0
F +49 (0) 8035 / 9840-300
info@bora.com
bora.com



BORA Vertriebs GmbH & Co KG

Innstraße 1
6342 Niederndorf
Österreich
T +43 (0) 5373 / 62250-0
F +43 (0) 5373 / 62250-90
mail@bora.com
bora.com



BORA Holding GmbH

Innstraße 1
6342 Niederndorf
Austria
T +43 (0) 5373 / 62250-0
F +43 (0) 5373 / 62250-90
mail@bora.com
bora.com



BORA APAC Pty Ltd

100 Victoria Road
Drummoyne NSW 2047
Australia
T +61 2 9719 2350
F +61 2 8076 3514
info@boraapac.com.au
bora-australia.com.au



005311-10001-01