

EN

Operating and installation instructions S Pure

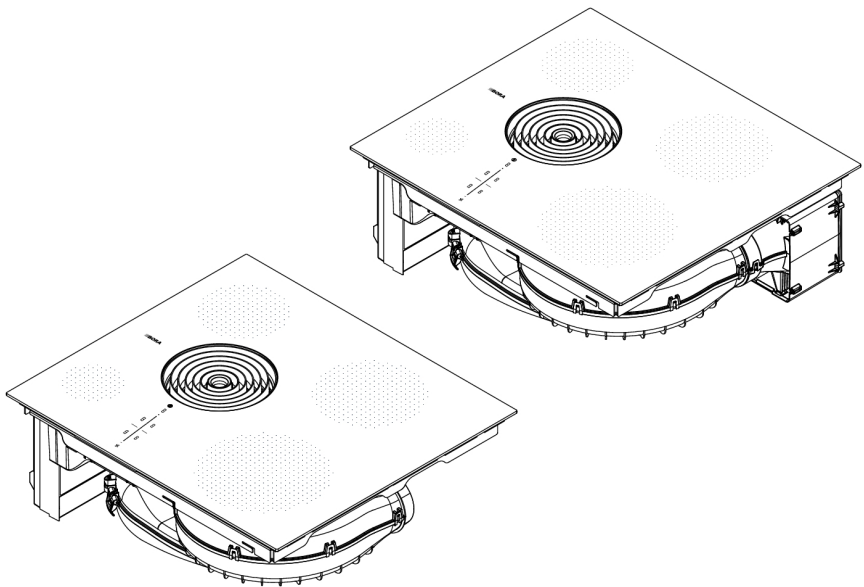

Contents

1	General information	86			
1.1	Validity of the operating and installation instructions	86	5.3	Function overview	110
1.2	Liability	86	5.4	Operating the system	110
1.3	Product conformity	86	5.4.1	Switching on	110
1.4	Presentation of information	86	5.4.2	Switching off	111
1.4.1	Safety and warning instructions	86	5.4.3	Short-time timer (egg timer).....	111
1.4.2	Figures	87	5.4.4	Operating lock.....	111
			5.4.5	Cleaning lock	112
2	Safety	88	5.5	Cooktop extractor functions	112
2.1	Intended use	88	5.5.1	Setting the fan power levels.....	112
2.2	People with limited abilities.....	88	5.5.2	Fan power setting	112
2.3	General safety instructions.....	89	5.5.3	Automatic extractor function	112
2.4	Safety information for installation.....	91	5.5.4	Switching the fan off	113
2.4.1	Safety instructions – cooktop extractor installation	93	5.5.5	Automatic after-run.....	113
2.4.2	Safety information for cooktop installation	94	5.5.6	Filter service display	113
2.5	Safety instructions – operation	95	5.6	Cooktop functions	113
2.5.1	Safety instructions – cooktop extractor operation	97	5.6.1	Pan size recognition	113
2.5.2	Safety instructions – cooktop operation.....	98	5.6.2	Selecting a cooking zone	113
2.6	Safety instructions – cleaning and maintenance	100	5.6.3	Setting cooking zone power levels....	114
2.6.1	Safety instructions – cleaning and maintenance of cooktop extractors ..	100	5.6.4	Cooking zone power setting.....	114
2.6.2	Safety instructions – cleaning and maintenance of cooktops.....	101	5.6.5	Automatic heat up function.....	114
2.7	Safety instructions – repairs, servicing and spare parts.....	101	5.6.6	Cooking zone timer	115
2.8	Safety instructions – disassembly and disposal	102	5.6.7	Pause function	115
			5.6.8	Heat retention function.....	116
			5.6.9	Coffee function	116
			5.6.10	Switching off the cooking zone	117
3	Technical data	103	5.7	Safety features	117
4	Appliance description	105	5.7.1	Child lock	117
4.1	Model description.....	105	5.7.2	Residual heat indicator.....	118
4.2	System description	105	5.7.3	Safety shut-down	118
4.2.1	Structure.....	105	5.7.4	Overheating protection	118
4.2.2	Operating panel and operating principle	105			
4.2.3	Symbols	106	6	User menu	119
4.2.4	7-segment display	107	6.1	Menu item 1: volume of the acoustic signals	119
4.2.5	Lighting	107	6.2	Menu item 2: Child lock	119
4.2.6	Sounds.....	107	6.3	Menu item 3: Show filter status and reset filter service display.....	120
4.3	How the cooktop extractor works... ..	107	6.4	Menu item 4: Duration of the automatic after-run function.....	120
4.4	How the induction cooktop works ..	108	6.5	Menu item 5: Touch zone reaction speed	121
5	Functions and operation	110	6.6	Menu item 6: LED test.....	121
5.1	General operating instructions	110	6.7	Menu item 7: Permanent pan size recognition	121
5.2	Touch control.....	110	6.8	Menu item 8: Show software/hardware version... ..	122
			6.9	Menu item 9: Safety shut-down.....	122
			6.10	Menu item A: Super simple mode....	122
			6.11	Menu item 0: Reset to factory settings.....	123

7	Cleaning and maintenance	124		
7.1	Cleaning agents	124	9.7.9	Making a connection with the back panel in installation variant A.... 142
7.2	Cooktop and extractor care	124	9.7.10	Inserting the activated charcoal filter .. 142
7.3	Cleaning the cooktop	124	9.8	Connecting the power supply
7.4	Cleaning the cooktop extractor	125	9.9	Initial operation
7.4.1	Removing the components.....	125	9.9.1	Dealer and service menu.....
7.4.2	Cleaning the air inlet nozzle and stainless steel grease filter	125	9.9.2	Menu item B: Extraction system configuration.....
7.4.3	Fitting the components	126	9.9.3	Menu item C: Power management
7.4.4	Removing liquids from the appliance...	126	9.9.4	Menu item D: demo mode.....
7.5	Cleaning the air guiding housing	126	9.9.5	Function test
7.6	Replace the activated charcoal filter	127	9.10	Sealing the appliance
			9.11	Handover to user
8	Troubleshooting	129	10	Decommissioning, disassembly and disposal
9	Installation	131	10.1	Decommissioning
9.1	General installation instructions	131	10.2	Disassembly.....
9.1.1	Simultaneous operation of the cooktop extractor in the exhaust air mode and a fireplace dependent upon the air supply in the room	131	10.3	Environmentally-friendly disposal ...
9.2	Scope of delivery	132	10.3.1	Disposal of transport packaging.....
9.3	Tools and aids.....	132	10.3.2	Disposal of accessories.....
9.4	Assembly instructions.....	132	10.3.3	Disposal of the old appliance
9.4.1	Installation clearances	132	11	Warranty, technical service, spare parts, accessories
9.4.2	Minimum unit dimensions for S Pure (PURSA, PURSU)	133	11.1	BORA manufacturer's warranty
9.5	Worktop cut-out	133	11.1.1	Warranty extension
9.5.1	S Pure cut-out dimensions	133	11.2	Service
9.6	Installing the appliance in exhaust air mode.....	134	11.3	Spare parts
9.6.1	Preparing kitchen units for the exhaust air model.....	134	11.4	Accessories.....
9.6.2	Installation dimensions	134	12	Energy data sheets
9.6.3	Preparing the cooktop.....	135	12.1	Energy data sheet for PURSA.....
9.6.4	Inserting the cooktop	135	12.2	Energy data sheet for S Pure
9.6.5	Connecting the appliance to the duct system	136		
9.7	Installing the appliance in recirculation mode	137		
9.7.1	Recirculation of air from the kitchen unit	137		
9.7.2	Installation variants A and B for recirculation appliances	137		
9.7.3	Preparing the kitchen unit for installation variant A	138		
9.7.4	Installation dimensions for installation variant A	139		
9.7.5	Preparing the kitchen unit for installation variant B	140		
9.7.6	Installation dimensions for installation variant B	140		
9.7.7	Preparing the cooktop.....	140		
9.7.8	Inserting the cooktop – recirculation...	140		

1 General information

These instructions contain important information to protect you from injury and prevent damage to the appliance. Please read these instructions carefully before installing or using the appliance for the first time. Other documents apply alongside these instructions. Please by all means adhere to all documents that form part of the scope of delivery.

Assembly, installation and commissioning must always occur in line with national laws, regulations and standards. The work must be performed by qualified specialists who know and comply with the additional regulations of the local energy supply companies. All safety and warning information as well as the handling instructions in the accompanying documents must be observed.

1.1 Validity of the operating and installation instructions

These instructions apply to several appliance versions. It is therefore possible that some of the features described do not apply to your appliance. The details of the figures contained herein may differ from some appliance versions and are to be understood as schematic diagrams.

1.2 Liability

. BORA Holding GmbH, BORA Vertriebs GmbH & Co KG, BORA APAC Pty Ltd and BORA Lüftungstechnik GmbH – hereinafter referred to as BORA – do not assume any liability for damage arising from disregard for or non-adherence to the documents included in the scope of delivery!

Furthermore, BORA shall not be held liable for damage caused by improper installation or failure to observe the safety and warning information!

1.3 Product conformity

Directives

The appliances meet the following EU/EC directives:

- 2014/30/EU EMC Directive
- 2014/35/EU Low Voltage Directive
- 2009/125/EC Ecodesign Directive
- 2011/65/EU RoHS Directive

Standards

The appliances conform to the following standards:

- IEC 61000-3-12

1.4 Presentation of information

We use standard formatting, numbering, symbols, safety instructions, terms and abbreviations so that you can work quickly and safely when using this manual. The article described in these instructions is hereinafter also referred to as an appliance.

Instructions are indicated with an arrow.

► Always follow all instructions in the prescribed order.

Enumerations are indicated with a bullet point at the start of the line:

- Enumeration 1
- Enumeration 2



Information notes point to special features that must be taken into account.

1.4.1 Safety and warning instructions

The safety and warning instructions in this manual are emphasised with symbols and signal words. Safety and warning instructions are structured as follows:

DANGER

Type and source of danger

Results of non-compliance

► Measures to minimise risk

Please note:

- warning symbols draw attention to a high risk of injury.
- The signal word indicates the severity of that risk.

Warning symbol	Signal word	Risk
	Danger	Indicates an immediate, hazardous situation which causes death or serious injury if not respected.
	Warning	Indicates a potentially hazardous situation which can cause death or serious injury if not respected.
	Caution	Indicates a potentially hazardous situation which can cause death or serious injury if not respected.
	Note	Indicates a potentially hazardous situation which can cause property damage if not respected.

Tab. 1.1 Meaning of the warning symbols and signal words

1.4.2 Figures

All measurements are provided in millimetres.

2 Safety

The appliance complies with the stipulated safety requirements. The user is responsible for the safe use of the appliance, cleaning and maintenance. Improper use can lead to personal injury and damage to property.

2.1 Intended use

The appliance is solely intended for preparing food in private households.

This appliance is not intended for:

- outdoor use
- heating rooms
- cooling, ventilating or dehumidifying rooms
- use in mobile installation sites such as motor vehicles, ships or aeroplanes
- use with an external timer or a separate remote control system
- use with an external timer or a separate remote control system (except for emergency shutdown in the case of the cooktop extractor)
- use at altitudes of over 2000 m (metres above sea level)
- use when not fully installed

Any other use or any use that goes beyond that which is described here is classed as unintended.

i BORA does not assume any liability for damages caused by incorrect installation, improper use or incorrect operation.

All misuse is prohibited!

2.2 People with limited abilities

Children

The appliance can be used by children aged 8 and over if they are supervised or have been instructed how to use the appliance safely and understand the resultant risks. Children must not play with the appliance.

- ▶ Use the childproofing feature in order to prevent children from switching on the appliance or changing the settings when they are unattended.
- ▶ Supervise children in the vicinity of the appliance.
- ▶ Do not store any items that could be of interest to children in storage spaces above or behind the appliance. Otherwise, they will be tempted to climb onto the appliance.

i Any work involving cleaning and maintenance must not be carried out by children unless they are supervised at all times while doing so.

People with reduced physical, sensory or mental capacities

The appliance can be used by people with reduced physical, sensory or mental capacities or a lack of experience and/or knowledge if they are supervised or have been instructed how to use the appliance safely and understand the resultant risks. Operation can be restricted using the child lock.

⚠ DANGER**Risk of burns from hot cookware and food**

Handles projecting over the edge of the worktop are asking to be grabbed.

- ▶ Keep children away from hot cooking zones or ensure they are supervised at all times.
- ▶ Do not turn pot and pan handles so they stick out beyond the work surface.
- ▶ Make sure that hot pots and pans cannot be pulled down.
- ▶ If necessary, use suitable stove guards or covers.
- ▶ Only use stove guards and covers that are approved by the appliance manufacturer; otherwise, there is a risk of accidents.
- ▶ To choose a suitable stove guard, contact your specialist retailer or the BORA Service Team.

2.3 General safety instructions**⚠ DANGER****Packaging components are a choking hazard**

Packaging components (e.g. film, polystyrene) can be life-threatening for children.

- ▶ Store all packaging components out of reach of children.
- ▶ Dispose of the packaging properly and immediately.

⚠ DANGER**Risk of electric shock or injury from damaged surfaces**

The underlying electronics can be exposed or damaged due to fissures, fractures or cracks in appliance surfaces (e.g. damaged glass), particularly in the vicinity of the operating unit. This can cause an electrical shock.

Furthermore, a damaged surface can cause injuries.

- ▶ Do not touch the damaged surface.
- ▶ If there are any cracks, fissures or fractures, switch the appliance off immediately.
- ▶ Securely disconnect the appliance from the mains using the circuit breaker, fuses, automatic circuit breakers or contactor.
- ▶ Contact BORA Service.

⚠ WARNING**Risk of injury or damage due to incorrect components or unauthorised modifications**

Incorrect components can lead to personal injury or damage to the appliance. Modifications, additions or alterations to the appliance can lead to safety risks.

- ▶ Only use original components.
- ▶ Do not make any modifications, additions or alterations to the appliance.

⚠ WARNING**Risk of injury due to mechanical damage on the appliance**

Mechanical damage (e.g. cracks, deformation, separation of adhesive seals, etc.) to the appliance, as well as to cables and accessories can cause injuries.

- ▶ Do not operate the appliance.
- ▶ Do not try to repair or replace damaged components yourself.
- ▶ Contact BORA Service.

CAUTION**Appliance components can cause injury if dropped**

Appliance components can cause injury if you drop them.

- ▶ Place any appliance components that have been removed in a safe place near the appliances.
- ▶ Ensure that no components removed from the appliances can fall on the floor.

CAUTION**Risk of injury from heavy lifting**

If not handled correctly, carrying and installing appliances can cause injury to the limbs or torso.

- ▶ If necessary, carry and install the appliance with another person.
- ▶ Use appropriate aids to prevent damage or injury.

CAUTION

Damage from improper use

The appliance surfaces must not be used as work or storage surfaces. This can damage the appliances (particularly in the case of hard and sharp objects).

- ▶ Never use the appliances as work or storage surfaces.
- ▶ Keep hard or sharp objects away from the appliance surfaces.

PLEASE NOTE

Faults and errors

In the event of faults or incorrect use, error messages will be displayed.

- ▶ In the case of faults and errors, follow the instructions in the “Troubleshooting” chapter.
- ▶ In the event of any faults or errors that are not mentioned, switch the appliance off and contact BORA Service.

PLEASE NOTE

Appliance damage caused by pets

Pets may damage the appliance or injure themselves.

- ▶ Keep pets away from the appliance.

2.4 Safety information for installation

DANGER

Risk of injury from incorrect assembly

Failure to observe the installation instructions can lead to injury.

- ▶ The appliance must only be installed and assembled by trained specialists who are familiar with and comply with the standard national regulations and supplementary regulations of the local utility companies.
- ▶ Work on electrical components must only be conducted by trained electrical personnel.
- ▶ Conduct all work extremely attentively and conscientiously.
- ▶ Before handing the appliance or system over to the end user, ensure that it has been correctly installed.

⚠ DANGER**Risk of electric shock from damaged appliance**

A damaged appliance can cause an electric shock.

- ▶ Check the appliance for visible damage prior to installation.
- ▶ Do not install or connect any damaged appliances.
- ▶ Do not operate any damaged appliances.

⚠ DANGER**Risk of electric shock from incorrect stripping of cables**

Incorrect stripping of the connection cable to external switching devices results in a risk of electric shock.

- ▶ Ensure that the connection cable is secured with the strain relief clamp within the control unit.
- ▶ Ensure that the stated stripping lengths are adhered to.

PLEASE NOTE**Appliance damage caused by incorrect wiring**

The electrical safety of the appliance is only guaranteed if it is connected to a protective conductor system that has been installed in line with regulations.

- ▶ Work on electrical components must only be conducted by trained electrical personnel.
- ▶ Ensure that this basic safety precaution is met. The appliance must be suitable for the regional voltage and frequency.
- ▶ Check the information on the identification plate and in the event of deviations, do not connect the appliance.
- ▶ Do not connect the appliance to the mains until the duct system has been installed or the recirculation filter has been fitted.
- ▶ Only use the connection cables supplied.

PLEASE NOTE**Appliance damage caused by incorrect installation clearances**

Failure to adhere to installation clearances can lead to damage to the appliance and kitchen units, as well as restricted functions.

- ▶ During installation maintain the minimum clearance stated in the Installation chapter.

2.4.1 Safety instructions – cooktop extractor installation** DANGER****Risk of smoke inhalation**

When the cooktop extractor is used in exhaust air mode, it draws in air from the room it is installed in and from neighbouring rooms. Without sufficient air, there will be a drop in air pressure. When used at the same time as a fireplace that is dependent on the air in the room, noxious gases can be sucked into the living areas from the chimney or outlet shaft.

- ▶ Make sure that there is always a sufficient air supply.
- ▶ Only use reliable, tried-and-tested switching devices, (e.g. window contact switch, low pressure warning device) and have them approved by a qualified expert (certified chimney sweep).

 WARNING**Risk of injury due to turning fan wheel**

There is a risk of injury while the fan is turning.

- ▶ Only install the device with the power disconnected.
- ▶ Connect both sides of the fan to the duct system before commissioning.

CAUTION**Risk of injury due to turning fan wheel**

There is a risk of the vicinity of the fan being reached in the case of short air channels.

- ▶ Never reach through the air outlet into the vicinity of the fan.
- ▶ Always install fans so that it is not possible to touch them via the air outlet.
- ▶ In the case of air channels shorter than 900 mm between the fan and air outlet, install a guard to prevent access.
- ▶ Activated charcoal filters do not provide sufficient protection.

2.4.2 Safety information for cooktop installation** DANGER****Risk of electric shock from damaged power supply cable**

If the power supply cable is damaged (e.g. during installation or by coming into contact with hot cooking surfaces), this can cause an (lethal) electric shock.

- ▶ Make sure that the connection cable does not become trapped or damaged.
- ▶ Make sure that the power supply cable does not come into contact with hot cooking surfaces.

 DANGER**Risk of electric shock from incorrect mains connection**

Connecting the appliance to the mains incorrectly poses a risk of electric shock.

- ▶ Make sure that the appliance has a fixed connection to the mains voltage.
- ▶ Make sure that the appliance is connected to a properly installed protective conductor system.
- ▶ Make sure that technical equipment is provided to enable all of the appliance's poles to be disconnected from the mains with a contact opening width of at least 3 mm (circuit breaker and automatic circuit breakers, fuses, contactor).

2.5 Safety instructions – operation

DANGER

Risk of fire from overheated oil or fat

Oil or fat in the pot can quickly heat up and ignite.

- ▶ Never leave the appliance unattended when cooking with oil or fat.
- ▶ Never extinguish oil and fat fires with water.
- ▶ Switch off the appliance.
- ▶ Extinguish the fire using a pan lid or a fire blanket, for example.

WARNING

Risk of burning from hot appliances

Certain appliances and their exposed parts become hot during use. They should be left to cool down completely after switching off. Touching hot surfaces can cause serious burns.

- ▶ Do not touch hot appliances.
- ▶ Pay attention to the residual heat indicator.

WARNING

Risk of burns due to power cut

During or after a power cut a cooktop that was previously in operation may still be hot.

- ▶ Do not touch the appliance while it is still hot.
- ▶ Keep children away from the hot appliance.

⚠ WARNING**Risk of burning and fire from hot objects**

The appliance and its exposed parts are hot during operation and the cooling phase. Objects in contact with hot appliance components heat up very quickly and can cause severe burns (this particularly applies to metal objects such as knives, forks, spoons, lids or appliance components) or catch fire.

- ▶ Do not place any items on the appliance.
- ▶ Please use suitable accessories (pot holders, oven gloves).
- ▶ Do not simply rely on the pan size recognition function on induction cooktops; always switch the appliance off after use.

CAUTION**Damage caused by hot cookware**

Hot cookware can damage certain components in the appliance.

- ▶ Do not put hot cookware down in the area of the operating panel or cooktop display.
- ▶ Keep hot cookware away from the air inlet nozzle.

PLEASE NOTE**Appliance damage**

Incorrect use may cause damage to the appliance.

- ▶ Make sure that the base of the cookware as well as the appliance surfaces are clean and dry.
- ▶ Always lift (do not drag) cookware to prevent scratching and abrasion on the appliance surface.
- ▶ Do not use the appliance as a storage surface.
- ▶ Always switch off the appliance after use.

2.5.1 Safety instructions – cooktop extractor operation

DANGER

Risk of smoke inhalation

When the cooktop extractor is used in exhaust air mode, it draws in air from the room it is installed in and from neighbouring rooms. Without sufficient air, there will be a drop in air pressure. When used at the same time as a fireplace that is dependent on the air in the room, noxious gases can be sucked into the living areas from the chimney or outlet shaft.

- ▶ Make sure that there is always a sufficient air supply.
- ▶ Only use reliable, tried-and-tested switching devices, (e.g. window contact switch, low pressure warning device) and have them approved by a qualified expert (certified chimney sweep).

WARNING

Fire risk from flambéing

While the cooktop extractor is working, it sucks up grease from cooking. Flambéing food can cause the grease to catch fire.

- ▶ Clean the cooktop extractor regularly.
- ▶ Never work with a naked flame while the cooktop extractor is running.

CAUTION

Damage caused by objects or paper suctioned in

Small and light items, such as cleaning cloths made from material or paper, can be suctioned into the cooktop extractor. This can damage the fan or impair the exhaust performance.

- ▶ Do not store any items or paper on the cooktop extractor.
- ▶ Only operate the integrated cooktop extractor with the grease filter fitted.

CAUTION**Damage caused by grease and dirt deposits**

Grease and dirt deposits can prevent the cooktop extractor from functioning properly.

- ▶ Never use the cooktop extractor without a correctly fitted stainless steel grease filter.

PLEASE NOTE**Increased humidity**

When cooking, additional moisture is released into the ambient air. In recirculation mode, only a slight amount of moisture is removed from the cooking vapour.

- ▶ When using the recirculation mode, ensure a sufficient supply of fresh air, e.g. by opening a window.
- ▶ Ensure a normal and comfortable room climate (humidity of 45 – 60%), e.g. by opening natural ventilation openings or using domestic ventilation systems.

2.5.2 Safety instructions – cooktop operation** DANGER****Danger of fire caused by leaving the cooktop unattended**

Oil or fat in the pot can quickly heat up and ignite.

- ▶ Never leave oil or fat to heat up unattended.
- ▶ Never extinguish oil and fat fires with water.
- ▶ Switch off the cooktop.
- ▶ Extinguish the fire using a pan lid or a fire blanket, for example.

 DANGER**Danger of explosion caused by flammable liquids**

Flammable liquids in the vicinity of a cooktop can explode and cause serious injury.

- ▶ Do not spray aerosols near the appliance when it is in use.
- ▶ Do not place any flammable liquids in the vicinity of a cooktop.

⚠ WARNING**Risk of burns from hot liquids boiling over**

Unattended pans can boil over allowing hot liquids to escape.

- ▶ Keep an eye on pans when cooking.
- ▶ Avoid over-cooking.
- ▶ Always switch off the appliance after use.

⚠ WARNING**Risk of burns from hot steam**

Liquid between the cooking zone and cookware base can evaporate and cause burns.

- ▶ Make sure that the cooking zone and the cookware base are always dry.

PLEASE NOTE**Damage caused by sugary and salty foods**

Sugary and salty foods and juices can damage the hot cooking zone.

- ▶ Make sure sugary and salty foods or juices do not get onto the cooking zone while it is hot.
- ▶ Remove sugary and salty foods and juices from the hot cooking zone immediately.

CAUTION**Electromagnetic radiation**

Effect on pace makers, hearing aids and metal implants. Induction cooktops generate a high-frequency electromagnetic field in the area of the cooking zones. The cooking zones may affect pacemakers, hearing aids or metal implants negatively or disturb their function when in close proximity.

- ▶ If in doubt, contact the manufacturer of your medical device or your doctor.

2.6 Safety instructions – cleaning and maintenance

PLEASE NOTE

Appliance damage due to soiled appliances

Dirt can lead to damage, restriction of functions, or bothersome odours.

- ▶ Clean the appliance regularly.
- ▶ Remove dirt immediately.
- ▶ When cleaning, only use non-abrasive detergents to prevent scratching and abrasion on the surface.
- ▶ When cleaning, ensure that no water penetrates the appliance. Use only a slightly damp cloth. Never spray the appliance with water. Water penetration can cause damage.
- ▶ Do not use a steam cleaner for cleaning. Steam can cause a short circuit on live parts and thus lead to property damage.
- ▶ Please follow all instructions in the “Cleaning and Maintenance” chapter.

2.6.1 Safety instructions – cleaning and maintenance of cooktop extractors

DANGER

Risk of fire from fat deposits

The risk of fire can be increased by failure to clean the grease filter properly and on a regular basis, or if the filter change is overdue.

- ▶ Clean and replace the filter at regular intervals.

WARNING

Risk of injury when opening the bottom housing cover

There is a risk of injury while the fan is turning.

- ▶ Switch off the appliance and disconnect it from the mains before removing covers in the vicinity of the fan.

PLEASE NOTE

Appliance damage and malfunctions

Soiled ventilation openings can lead to component damage and malfunctions.

- ▶ Keep all ventilation openings open and clean.

2.6.2 Safety instructions – cleaning and maintenance of cooktops

WARNING

Risk of burns from hot surfaces

There is a risk of burns when cleaning hot cooktops.

- ▶ Only clean the cooktops once they have cooled.
- ▶ Pay attention to the residual heat indicator.

2.7 Safety instructions – repairs, servicing and spare parts

DANGER

Risk of injury when carrying out repairs

Insufficient expertise can lead to injury when carrying out repairs.

- ▶ The appliance must only be repaired and serviced by trained specialists who are familiar with and comply with the standard national regulations and supplementary regulations of the local utility companies.
- ▶ Safely disconnect the appliance from the mains supply.
- ▶ Work on electrical components must only be conducted by trained electrical personnel.
- ▶ A damaged power supply cable must be replaced by a suitable power supply cable.

WARNING

Risk of injury or damage from improper repairs

Incorrect components can lead to personal injury or damage to the appliance. Modifications, additions or alterations to the appliance can lead to safety risks.

- ▶ Only use original spare parts for repairs.
- ▶ Do not make any modifications, additions or alterations to the appliance.

2.8 Safety instructions – disassembly and disposal

DANGER

Risk of injury during disassembly

Insufficient expertise can lead to injury when disassembling the appliance.

- ▶ It must only be disassembled by trained specialists who are familiar with and comply with the standard national regulations and supplementary regulations of the local utility companies.
- ▶ Safely disconnect the appliance from the mains supply.
- ▶ Work on electrical components must only be conducted by trained electrical personnel.

DANGER

Risk of electric shock from incorrect disconnection

Incorrectly disconnecting the appliance from the mains results in a risk of electric shock.

- ▶ Safely disconnect the appliance from the mains supply.
- ▶ Use an authorised measuring device to ensure that there is no power to the appliance.
- ▶ Do not touch exposed contacts on the electronic unit as they may contain residual charge.

DANGER

Risk of electric shock from residual charge

Electrical components in the appliance can contain residual charge and cause an electric shock.

- ▶ Do not touch any exposed contacts.

3 Technical data

Parameter	Value
Multiphase supply voltage	380–415 V 2N/3N
Single-phase supply voltage	220–240 V
Frequency	50–60 Hz
Maximum power consumption	7250 W
Three-phase power supply/fuse protection	3 x 16 A
Two-phase power supply/fuse protection	2 x 16 A
Single-phase power supply/fuse protection	1 x 32 A (1 x 20 A / 1 x 16 A)
Dimensions (width x depth x height)	580 x 515 x 199 mm
Weight (incl. accessories/packaging)	18.3 kg (PURSA) 20.2 kg (PURSU)

Cooktop

Front left cooking zone size	Ø 95 mm
Front left cooking zone output	400 W
Front left cooking zone power setting output	600 W
Front right cooking zone size	Ø 210 mm
Front right cooking zone output	2300 W
Front right cooking zone power setting output	3000 W
Rear left cooking zone size	Ø 140 mm
Rear left cooking zone output	900 W
Rear left cooking zone power setting output	1350 W
Rear right cooking zone size	Ø 175 mm
Rear right cooking zone output	1400 W
Rear right cooking zone power setting output	2100 W

Cooktop energy consumption (pan size)

Front left cooking zone	not applicable
Rear left cooking zone	150 mm 194.2 Wh/kg
Front right cooking zone	210 mm 189.3 Wh/kg
Rear right cooking zone	180 mm 182.5 Wh/kg
Total (average)	188.7 Wh/kg

Parameter	Value
Exhaust air system	
Cooktop extractor power levels	1–9, P
Exhaust air connection	BORA Ecotube
Recirculation system	
Cooktop extractor power levels	1–9, P
Size of exhaust opening (W x H)	445 x 137 mm
Activated charcoal filter service life	150 hrs (1 year)

Tab. 3.1 Technical data for S Pure

PURSA appliance dimensions

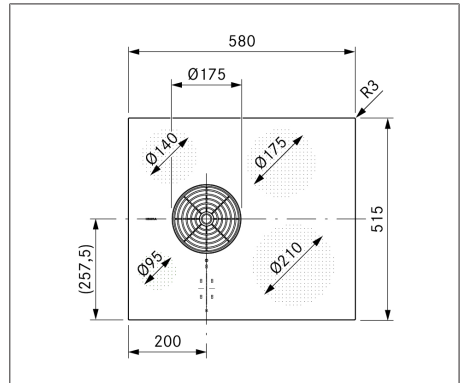

Fig. 3.1 PURSA top view

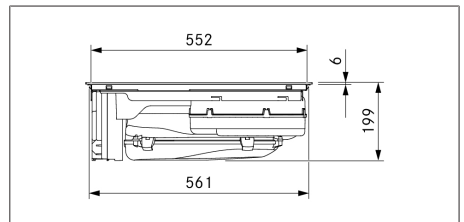

Fig. 3.2 PURSA front view

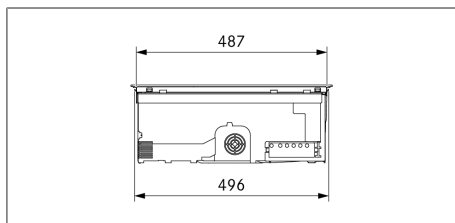

Fig. 3.3 PURSU side view

PURSU appliance dimensions

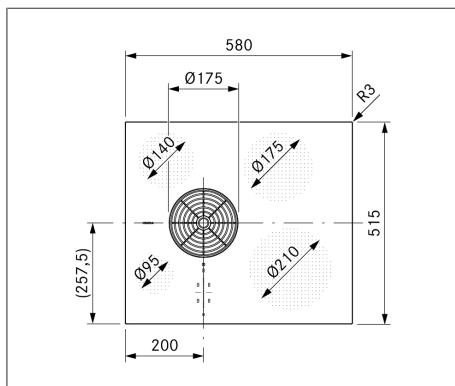

Fig. 3.4 PURSU top view

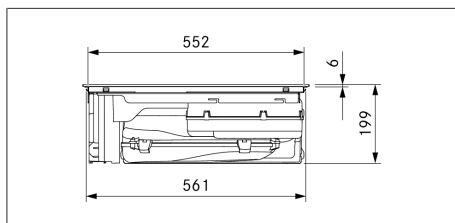

Fig. 3.5 PURSU front view

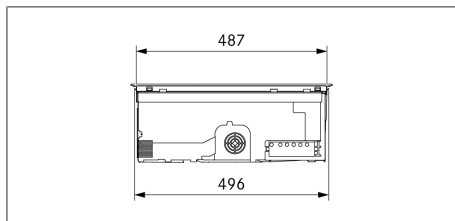

Fig. 3.6 PURSU side view

4 Appliance description

- Observe all safety and warning information (see "2 Safety").

4.1 Model description

Model	Long description
PURSA	S Pure induction cooktop with integrated cooktop extractor – exhaust air
PURSU	S Pure induction cooktop with integrated cooktop extractor – recirculation

Tab. 4.1 Model description

4.2 System description

4.2.1 Structure

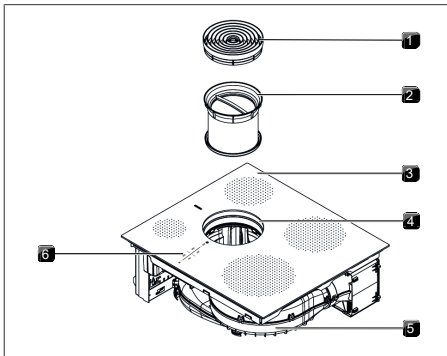

Fig. 4.1 Cooktop

- [1] Air inlet nozzle
- [2] Stainless steel grease filter
- [3] Cooktop
- [4] Inlet opening
- [5] Fans
- [6] Operating panel

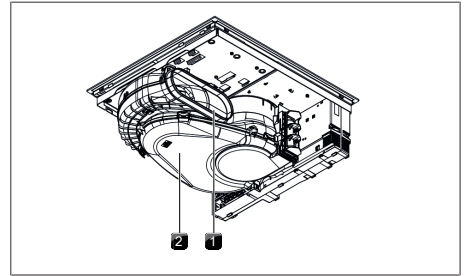

Fig. 4.2 Rear view of PURSA

- [1] Exhaust opening
- [2] Air guiding housing with housing base

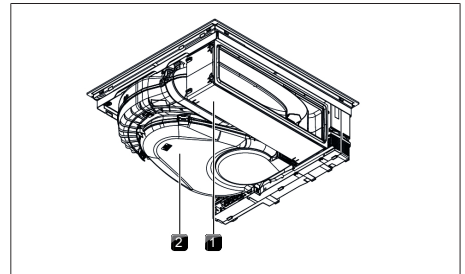

Fig. 4.3 Rear view of PURSU

- [1] Air cleaning box with telescopic pull-out
- [2] Air guiding housing with housing base

4.2.2 Operating panel and operating principle

- i** How it works and its functions are described in more detail in the "Functions and operation" chapter.

The cooktop extractor and cooktops are operated via a central operating panel. The operating panel is fitted with electronic sensor buttons and display panels. The sensor buttons respond to finger contact (touch zones).

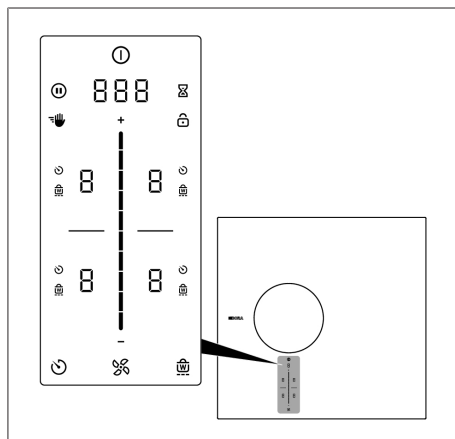

Fig. 4.4 Central touch/slider operating panel

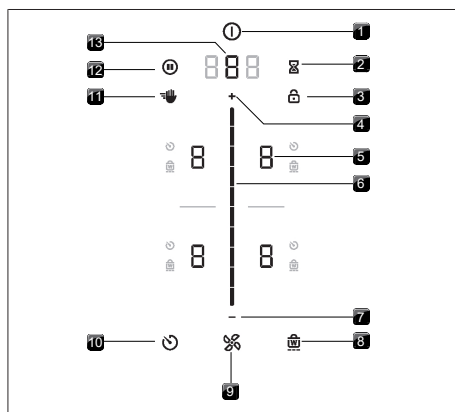

Fig. 4.5 Touch zones/buttons

- [1] Switching on/off
- [2] Short-time timer (egg timer)
- [3] Operating lock
- [4] Plus setting area
- [5] Cooking zone selection (x 4)
- [6] Touch slider (setting area)
- [7] Minus setting area
- [8] Heat retention function
- [9] Fan functions
- [10] Cooking zone timer
- [11] Cleaning lock
- [12] Pause function
- [13] Select fan/Call up menu

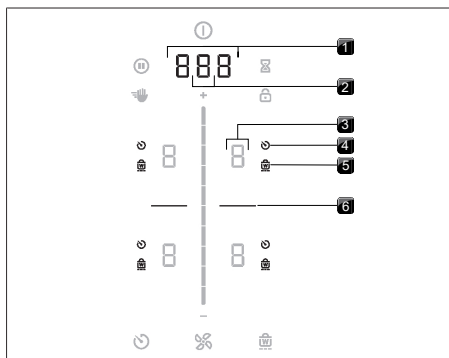

Fig. 4.6 Indicator zones

- [1] Multi-function display
- [2] Fan display
- [3] Cooking zone indicator (x 4)
- [4] Cooking zone timer indicator (x 4)
- [5] Heat retention function indicator (x 4)
- [6] Dividing line

4.2.3 Symbols

General symbols	Designation	Function/operation
	Power button	Switching on/off
	Pause button	Activating/deactivating the pause function
	Cleaning button	Activating/deactivating the cleaning lock
	Short-time timer button	Setting the short-time timer (egg timer)
	Lock button	Control lock
	Slider	Setting values
	Plus button	Increasing values
	Minus button	Decreasing values
	Fan button	Activating/deactivating the automatic extractor function, cancelling the after-run function
	Timer button	Setting the cooking zone timer
	Warming button	Heat retention function activation/deactivation

Tab. 4.2 Meaning of the symbols displayed (icons)

4.2.4 7-segment display

Multi-function display	Meaning
Fan display	Power levels
	Power setting
	Inactive
	Automatic extractor function
	Automatic after-run
	Filter service display
Multi-function display	Time indication
	e.g. Error code
Cooking zone indicator	Meaning
Cooking zone indicator	Power level
	Power setting
	Heat retention level
	Coffee function
	Pan size recognition
	Inactive
	Residual heat indicator (cooking zone is switched off but still hot)
	Error

Tab. 4.3 Meaning of the 7-segment displays

4.2.5 Lighting

- The operating panel has 2 different levels of lighting (100% and 50%).
- On principle the system adapts the lighting to the current operating scenario. Relevant display elements are more brightly lit and irrelevant ones are dimmed. Unavailable functions are faded out.

Lighting	Use
100%	Function is active and selected
50%	Function is inactive and can be selected
0%	Function is unavailable

Tab. 4.4 Lighting

4.2.6 Sounds

- The volume of the acoustic signals can be set in the menu (0% to 100%).
- The acoustic signal for the power button cannot be set to 0.
- Safety-relevant acoustic signals are always emitted with the volume at 100%.

The system basically differentiates between two different types of acoustic signals:

Acoustic signal	Purpose
Short beep (0.25 s)	Confirmation of a selection
Sequence of beeps	Interaction required

Tab. 4.5 Sounds

4.3 How the cooktop extractor works

Depending on the model you purchased, the cooktop extractor can be operated as an exhaust air or a recirculating air version.



Exhaust air

The air suctioned away is purified by the grease filter and expelled into the open air via a duct system.

The exhaust air must not be expelled into:

- a smoke or exhaust gas flue that is in operation
- a shaft used for the aeration of rooms where fireplaces are installed.

If the exhaust air is to be directed into a smoke or exhaust gas flue that is not in use, the installation must be checked and approved by the responsible heating engineer.



Recirculation

The air suctioned away is purified by the grease filter and an activated charcoal filter and fed back into the room in which the appliance is installed.

To prevent odours in recirculation mode, an odour filter must be used. For health and hygiene reasons, the activated charcoal filter must be replaced at the recommended intervals (Cleaning and maintenance).

i In recirculation mode, ensure sufficient ventilation and aeration to expel humidity.

4.4 How the induction cooktop works

An induction coil is located underneath an induction cooking zone. If the cooking zone is switched on, this coil creates a magnetic field that acts directly on the base of the pot thus heating it up. The cooking zone is only indirectly heated up by the heat emitted by the pot. Cooking zones with induction only work if the cookware has a magnetisable base.

Induction automatically takes into account the size of the cookware used which means that only the area in the cooking zone covered by the base of the pot is heated up.

► Observe the minimum pot base diameter.

Power levels

The high power output of induction cooktops results in the very quick heating up of cookware. In order to avoid burning food, slight adjustment is needed in comparison to conventional cooking systems when selecting the power level.

Activity	Power level
Melting butter and chocolate, breaking up gelatine	1
Keeping sauces and soups warm, soaking rice	1-3
Cooking potatoes, pasta, soups and ragouts, steaming fruit, vegetables and fish, defrosting food	2-6
Frying in coated pans, moderate frying (without overheating the fat) of pork cutlets or fish	6-7

Activity	Power level
Heating up fat, browning meat, cooking thickened sauces and soups, making omelettes	7-8
Bringing large amounts of liquid to the boil, searing steaks	9
Heating up water	P

Tab. 4.6 Recommendations for power levels

The specifications provided in the table are standard values. Depending on the cookware and filling quantity, it is recommended to either decrease or increase the power level.

Suitable cookware

 Cookware with this symbol is suitable for induction cooktops. The cookware used for the induction cooktop must be made of metal, feature magnetic properties and possess an ample base.

Suitable cookware is made of:

- stainless steel with a magnetisable base
- enamelled steel
- cast iron

Appliance	Cooking zone	Minimum cookware base diameter
S Pure	front left	70 mm
	rear left	80 mm
	front right	120 mm
	rear right	90 mm

Tab. 4.7 Minimum cookware diameter

- Perform a magnet test, if necessary. If a magnet sticks to the base of the utensils, they are normally induction compatible.
- Pay attention to the cookware base. The base of the cookware should not show any sign of curvature (exception: wok cooktops). Due to incorrect hob temperature monitoring, this curvature may cause the cookware to overheat. To avoid scratching the cooktop, the base of the cookware must not have any sharp grooves or sharp edges.
- Place the cookware (without a mat or similar) directly onto the glass ceramic.

- i** The heating and heat-through times for the cookware base, as well as the cooking results, are significantly influenced by the structure and material of the cookware.

Noises

The following noises may occur in the cookware when using induction cooking zones, depending on the material and the finish of the base:

- Humming may occur when using a high power level. This decreases or disappears when the power level is decreased.
- Crackling or whistling may occur due to cookware bases being made of different materials (e.g. sandwich base).
- Clicking sounds may occur during electronic switching procedures, especially at low power levels.
- Whirring may occur when the cooling fan is switched on. In order to increase the service life of the electronic system, the cooktop is equipped with a cooling fan. The cooling fan switches on automatically if the cooktop is used intensively. You will hear a whirring sound. The cooling fan may continue to run after the appliance has been switched off.

5 Functions and operation

- i** The integrated cooktop extractor must not be used with other cooktops.
- i** The cooktop should only be operated when the filter replacement cover, stainless steel grease filter and air inlet nozzle are installed (as well as the activated charcoal filter in the recirculation model).

► Observe all safety and warning information (see "2 Safety").

5.1 General operating instructions

The cooktop extractor and cooktops are operated via a central operating panel. The operating panel is fitted with electronic sensor buttons and display panels. The sensor buttons respond to finger contact. You operate the appliance by tapping the corresponding sensor button with your finger (touch control) or by a swipe of your finger (slider operation).

5.2 Touch control

The system recognises different touch commands. It differentiates between a brief touch (tap), a prolonged touch (long press) and vertical sliding movements with your finger (swiping).

Touch commands	Applicable to	Time (contact)
Tap	Buttons + slider	0.3 s
Long press	Buttons + slider	1–8 s
Swipe	Slider	0.1–8 s

Tab. 5.1 Touch control

5.3 Function overview

The S Pure cooktop with integrated cooktop extractor has the following functions:

Global functions

- Electronic power adjustment
- Short-time timer (egg timer)

Cooktop extractor

- Automatic extractor control
- Automatic after-run
- Cooktop extractor power setting
- Filter service display

Cooktop

- Automatic heat up function
- Pan size recognition
- Permanent pan size recognition
- Heat retention function
- Cooking zone timers (automatic cut-off)
- Pause function
- Cooking zone power setting
- Coffee function

Safety features

- Child lock
- Operating lock
- Cleaning lock (wipe function)
- Residual heat indicator
- Safety shut-down
- Overheating protection

5.4 Operating the system

5.4.1 Switching on

- Long press on the power button .
- The switch-on animation is displayed in the slider.
- If start-up is successful, the standard display will appear in the operating panel.

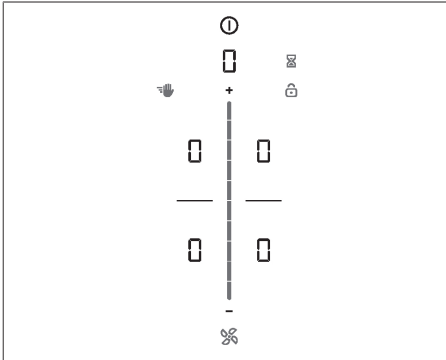

Fig. 5.1 Standard display after switching on

- i** When the child lock is active, the lock button lights up after system start . The standard display will only appear once it has been unlocked (Child lock).

5.4.2 Switching off

- ▶ Long press on the power button .
- The switching-off animation is displayed.

If the cooktop extractor has been on:

- The fan symbol will light up and the automatic after-run function will start (the automatic after-run animation is displayed).
- The display goes out when the after-run time has lapsed.

If the cooktop has been on:

- The residual heat indicator is displayed for previously active and still hot cooking zones.
- The display goes out when no more residual heat is present.

5.4.3 Short-time timer (egg timer)

The short-time timer emits both a visual and an acoustic signal after a time set by the user and provides the function of a conventional egg timer.

Activating the short-time timer

- ▶ Tap the short-time timer button .
- The time flashes in the multi-function display above the slider in minutes ().
- The cooking zones in the display are dimmed.

Setting the time

- ▶ Set the desired time:

Command	Increase time	Decrease time
Swipe	upwards	downwards
Tap	(exact to the minute)	(exact to the minute)

Tab. 5.2 Setting the time

- The short-time timer button begins to flash.

Starting the short-time timer

- ▶ Tap the flashing short-time timer button .
- The set time starts to count down.
- The remaining time is shown in the multi-function display.
- The short-time timer button is shown.

Time lapsed

- 10 seconds before the set time lapses, the system flashes the remaining time.
- In the last 5 seconds of the countdown an acoustic signal can be heard every second.
- The time indicator changes to the fan power level.

Deactivating the short-time timer early

- ▶ Long press on the short-time timer button .
- The short-time timer is stopped.
- The operating panel display changes to the standard display.

- i** If the appliance is switched off, the short-time timer will remain active.

5.4.4 Operating lock

The control lock prevents the current settings from being changed accidentally or without permission.

- If the control lock is active, the symbol lights up
- The functions are locked and the indicators on the display are dimmed (exception: On/Off touch button).

Activating the control lock

- ▶ Long press on the lock button .
- The operating panel display is dimmed.
- The lock button lights up.

- All functions are deactivated except for the power button and the lock button.

i If the system is switched off when the control lock is active, the control lock will no longer be active when the appliance is switched on again.

Deactivating the control lock

- ▶ Long press on the lock button .
- The standard display lights up and the operating panel is reactivated.
- The lock button is dimmed.

5.4.5 Cleaning lock

The cleaning lock prevents settings from being changed when wiping the operating panel during a cooking session. When activated, the operating panel is locked for 10 seconds. The remaining time is displayed. All appliance settings remain unchanged in the meantime.

Activating the cleaning lock

- ▶ Tap the cleaning button .
- The cleaning button lights up.
- The operating panel is locked for 10 seconds.
- The timer appears in the multi-function display and automatically counts down.

Deactivating the cleaning lock

- Once the timer has stopped you can use the functions again.



or

- ▶ long press on the cleaning button .
- The cleaning button is dimmed.
- The operating panel is unlocked.

5.5 Cooktop extractor functions

5.5.1 Setting the fan power levels



The fan power levels can be adjusted in different ways:

- ▶ by tapping  or 
- ▶ adjustment using the slider 
- ▶ by tapping a certain position on the slider 

5.5.2 Fan power setting

When the power setting is activated, maximum extractor power is available for a predefined time. This power setting makes it possible to suction away high levels of cooking vapours more quickly. After 5 minutes, the power setting is automatically switched back to power level 9.

Activating the fan power setting

- ▶ Tap  when power level 9 is active.
-  appears in the fan display.

Deactivating the fan power setting

The fan power setting is deactivated early if another power level is set.

5.5.3 Automatic extractor function



The extractor power level automatically adjusts itself depending on the current cooktop settings. No manual adjustment of the fan controls is necessary but it is possible. The extractor power is automatically adjusted to the highest power level used on all cooking zones that are currently in use.

Function	Power levels									
Cooking level	1	2	3	4	5	6	7	8	9	P
Extractor power	4	4	4	4	5	6	7	8	9	P

Tab. 5.3 Extraction performance and cooking level

- If the cooking zone power level is changed, the extractor power is automatically adjusted. The extractor power is adjusted after a 20 second delay.

Activating the automatic extractor function for a cooking session:



- ▶ tap the fan button .
- The fan symbol lights up.
- An animation appears on the slider.
-  is displayed.

Deactivating the automatic extractor function:

- ▶ Swipe to a fan power level.
- or
- ▶ tap the fan button .

5.5.4 Switching the fan off

Switching the fan off

- ▶ Swipe downwards to power level 0
- or
- ▶ tap  until power level 0 is reached
- or
- ▶ long press on the fan button 
- or
- ▶ Long press on the fan power level in the multi-function display.
- the automatic after-run function is started.

5.5.5 Automatic after-run

The cooktop extractor continues to run at a lower level and switches off automatically after a defined time. The duration of the after-run function can be set in the menu (10, 15 or 20 minutes). The default duration of the after-run function is 20 minutes.

- When the extractor is switched off, the automatic after-run function is activated.
- Once the automatic after-run period has lapsed, the cooktop extractor switches itself off.

Switching off the automatic after-run early

- ▶ Long press on the fan button 
- The cooktop extractor after-run function is switched off.

-  BORA expressly recommends use of the cooktop extractor after-run function.

5.5.6 Filter service display



The cooktop extractor filter service display is automatically activated when the end of the activated charcoal filter service life is reached (only in recirculation mode).

- **F** is displayed in the multi-function display.
- The filter service display is shown every time the cooktop extractor is switched on and remains active until the filter has been changed and the filter service display has been reset (see "6.3 Menu item 3: Show filter status and reset filter service display").
- The cooktop extractor can still be operated without limitations.

-  The components of the grease filter require regular cleaning regardless of the filter service display, see "8 Cleaning and Maintenance".

5.6 Cooktop functions

5.6.1 Pan size recognition

On induction cooktops the cooking zone recognises the size of the cookware automatically and only targets the energy at that area. It also recognises cookware that is unsuitable or too small, or if there is no cookware present. A cooking zone is not working if  /  are alternated in the display. This happens if

- it is switched on without cookware or with unsuitable cookware;
- the base diameter of the cookware is too small;
- the cookware is removed from a switched-on cooking zone.

If no pot is recognised 10 minutes after setting a power level, the cooking zone will switch off automatically.

Permanent pan size recognition

The appliance automatically recognises cookware and activates the corresponding cooking zone controls. Manual selection of the cooking zone is not necessary (see "6.7 Menu item 7: Permanent pan size recognition").

-  Do not simply rely on the pan size recognition function on induction cooktops; always switch the appliance off after use.

5.6.2 Selecting a cooking zone

- ▶ Tap the cooking zone display.
-  is displayed in the cooking zone display.
- The additional cooking zone functions appear.
- The cooking zone controls are activated for 2 seconds and you can apply settings to the chosen cooking zone.
- ▶ Repeat this process to operate further cooking zones if necessary.

5.6.3 Setting cooking zone power levels

- ▶ Tap the corresponding cooking zone display.
- The controls are activated for 2 seconds and you can set a power level for the chosen cooking zone.

The cooking zone power levels can be set in 3 different ways:

- ▶ by tapping a certain position on the slider
- or
- ▶ by swiping until you reach the required power level
- or
- ▶ by tapping **+** or **-**.
- ▶ Repeat this process to operate further cooking zones if necessary.

i The cooking zone power levels are shown in the corresponding cooking zone display as a 7-segment font.

i Two seconds after the power level is changed, the operating panel display automatically returns to the standard display.

5.6.4 Cooking zone power setting

When the power setting is activated, maximum cooking zone power is available for a predefined time.

- The power setting can be used on all cooking zones at the same time, provided that a restricted operating mode has not been set under the power management setting.
- After 5 minutes, the cooking zone is automatically switched back to power level 9.

i Never heat up oil, fat and the like on the power setting. The bottom of the pan can overheat due to the high power output.

Activating the power setting for a cooking zone

- ▶ Tap **+** when power level 9 is active.
- **P** appears in the cooking zone display.

Deactivating the power setting

the power setting is deactivated early if another power level is set.

5.6.5 Automatic heat up function

When the automatic heat up function is activated, the cooking zone works at full power for a certain time and is then automatically reset to the previously set level.

Power level (continuous cooking level)	Cooking duration in min:sec.
1	0:40
2	1:00
3	2:00
4	3:00
5	4:20
6	7:00
7	2:00
8	3:00

Tab. 5.4 Heating time overview

Activating the automatic heat up function

- ▶ Tap the corresponding cooking zone display.
- ▶ Adjusting the power level.
- ▶ Long press on the slider **----** at a position lower than power level 9
 - The automatic heat up function is activated.
 - Whilst the automatic heat up function is active, the power level displayed will flash.
 - When the heat up time has ended, the cooking zone will stay on the previously set power level (continuous cooking level).

Deactivating the automatic heat up function early

The automatic heat up function is deactivated early if a lower power level is set.

i If the cooking zone power level is increased while the automatic heat up function is active, the automatic heat up function remains active. The heating time is adjusted accordingly.



i If the cooking zone power level is decreased while the automatic heat up function is active, the automatic heat up function is deactivated.

5.6.6 Cooking zone timer

This automatic cut-off function automatically switches off the selected cooking zone once a preset time has lapsed. The timer function can also be used on several cooking zones at the same time (multi-timer).





- i** To be able to activate the cooking zone timer function, a cooking zone power level must first be set.

Activating cooking zone timers

- ▶ Tap the corresponding cooking zone display
 - The additional cooking zone functions are displayed.
 - If the chosen cooking zone is not yet active (= power level ) a power level can now be set.
- ▶ Tap the timer button .
 - The time flashes in the multi-function display above the slider in minutes ().

Setting the time



- ▶ Set the desired time:

Command	Increase time	Decrease time
Swipe	 upwards	 downwards
Tap	 (exact to the minute)	 (exact to the minute)

Tab. 5.5 Setting the time

- The timer symbol  starts to flash.

Starting the timer

- ▶ Tap the flashing timer button 
 - The set time starts to count down.
 - The timer symbol  is shown next to the cooking zone.
 - The operating panel display changes to the standard display after 2 seconds.
 - 10 seconds before the set time lapses, the system flashes the remaining time.
 - In the last 5 seconds of the countdown an acoustic signal can be heard every second.

Showing the remaining time

The cooking zone timer is active and the time counts down:



- ▶ Tap the cooking zone

- The remaining time is shown in the multi-function display.

Changing active timers

- ▶ Tap a cooking zone with an active timer
 - The remaining time is displayed.
- ▶ Tap the timer button 
 - The timer is stopped.
 - The remaining time flashes in the display.
 - The system changes to timer editing mode.
- ▶ Change the set time.
- ▶ Confirm the new set time and start the timer.



Multi-timer

- ▶ Tap on a different cooking zone display
 - The additional cooking zone functions are displayed.
 - If the chosen cooking zone is not yet active (= power level ) a power level can now be set.
- ▶ Tap the timer button 
 - The time flashes in the multi-function display above the slider in minutes ().
 - Now the time can be set and the timer started.

Switching the timer off early

- ▶ Tap a cooking zone display with an active timer
- ▶ Long press on the timer button 
 - or
 - ▶ long press on the cooking zone display with an active timer
 - The cooking zone timer ends.
 - The system switches to the standard display.
 - The cooking zone remains active on the set power level.

Time lapsed

- 10 seconds before the set time lapses, the system flashes the remaining time.
- In the last 5 seconds of the countdown an acoustic signal can be heard every second.
- The time display  and the timer button  flash.
- At the end of the set time the cooking zone is automatically deactivated (= power level .

5.6.7 Pause function

With the pause function all cooking zones can be quickly and easily deactivated temporarily. When the function is cancelled, operation resumes at the original

settings. The cooking session can be paused for a maximum of 10 minutes. Once 10 minutes have lapsed, the cooking session is automatically ended.

Activating the pause function

- ▶ Tap the pause button .
- The pause button lights up, all cooking sessions are paused and an acoustic signal is heard.
- The cooking zone indicators are dimmed.
- The pause timer is started (max. 10 min).

i During the pause, fan function is not interrupted. Active bridging and short-time timer functions remain active. Active cooking zone timers are stopped.



Deactivating the pause function

- ▶ Long press on the pause button .
- The pause button is dimmed.
- The cooking zone indicators light up.
- All cooking sessions are resumed at the power levels set prior to the pause.
- Active cooking zone timers are resumed.

5.6.8 Heat retention function

The heat retention function enables meals that have already been cooked to be kept warm at a lower temperature without any risk of burning. The maximum duration for the heat retention function is preset to 8 hours.

Activating the heat retention function

- ▶ Tap the corresponding cooking zone display.
- The additional cooking zone functions appear.
- ▶ Tap the heat retention button .
- The heat retention function is activated.
-  is displayed in the cooking zone display.
- The heat retention symbol  is shown next to the cooking zone.

Deactivating the heat retention function

- ▶ Tap the corresponding cooking zone display.
 - ▶ Tap the heat retention button .
 - or
 - ▶ swipe right down to the bottom (power level 0).
 - The heat retention function is deactivated.
- Selecting a power level also deactivates the heat retention function.

5.6.9 Coffee function

The coffee function automatically controls the brewing of coffee in an espresso pot.

- i** The coffee function can be used in both of the left cooking zones.
- i** The espresso pot must be suitable for induction cooktops.

Determining the water fill quantity of the espresso pot

You must specify the right water fill quantity of the espresso pot to be able to use the coffee function. The following values are set by default:



Cooking zone	Fill quantity
Front left cooking zone (Ø 95 mm)	210 ml
Rear left cooking zone (Ø 135 mm)	280 ml



Tab. 5.6 Preset water fill quantities

You can determine the appropriate water fill quantity for your espresso pot by filling the bottom chamber with water to just below the safety valve and pouring it into a measuring jug.

Setting the water fill quantity

A water fill quantity from 50 ml to 900 ml can be set.

- ▶ Tap the required cooking zone.
- The additional cooking zone functions are displayed.
- ▶ Tap the heat retention button twice .
- ▶  flashes in the cooking zone display.
- ▶ The set fill quantity is shown for 2 seconds in the fan display and in the slider.
- ▶ Enter the fill quantity as accurately as possible:

Entry	Increase quantity	Decrease quantity
100 ml intervals	Swipe upwards	Swipe upwards
10 ml intervals	Tap 	Tap 

Tab. 5.7 Entering the fill quantity



- ▶ Long press on the indicator .
- The setting is saved and the operating panel switches to the standard display.

- The setting is saved until another change is made on the appliance.

Preparing the espresso pot



- ▶ Fill the bottom chamber with cold water to just below the safety valve.
- ▶ Insert the filter funnel.
- ▶ Fill the filter funnel to the brim with ground coffee and level it
 - without pressing down the coffee.
- ▶ Screw the top chamber firmly onto the base.
- Both chambers must be screwed together tightly.
- ▶ Put the espresso pot on the cooking zone.

Activating the coffee function

- ▶ Tap the required cooking zone.
- The additional cooking zone functions are displayed.
- ▶ Tap the heat retention button  twice.
 -  flashes in the cooking zone display.
 - The set fill quantity is shown for 2 seconds in the fan display and in the slider.

Starting the coffee function

The function can be started as long as the fill quantity is shown in the fan display.

- ▶ Tap the indicator .
- The remaining time is shown in the multi-function display.
- The operating panel display changes to the standard display after 2 seconds.
- The heat retention symbol  and the timer symbol  are shown next to the cooking zone.

Time lapsed

- 10 seconds before the time lapses, the system flashes the remaining time.
- In the last 5 seconds of the countdown an acoustic signal can be heard every second.
- The time indicator  changes to the fan power level.
- Once the time has lapsed the cooking zone is automatically deactivated (= power level 0).

The coffee function is active and the time counts down:

- ▶ Tap the indicator .
- The remaining time is shown for 2 seconds in the multi-function display.

Hints and tips

Coffee is ready too early:

- The filled water quantity is too low.
- The set water quantity is to high.





- The ground coffee is too coarse (the coffee may taste watery).
- The filled water is too warm. If no cooler water is available, slightly reduce the set water fill quantity.
- The filter funnel is not filled to the brim with ground coffee.

Some of the coffee doesn't run through:

- The filled water quantity is too high.
- The water quantity is too low.
- The ground coffee is too fine (the coffee may taste bitter).
- The espresso pot wasn't screwed together tightly.
- The filter funnel contains too much coffee or the ground coffee is compressed.

-  The running time may vary slightly between the two cooking zones.

5.6.10 Switching off the cooking zone

- ▶ Tap the required cooking zone.
- ▶ Swipe right down to the bottom until  appears in the cooking zone display
- or
- ▶ long press on the cooking zone
 -  is displayed in the cooking zone display.
 - After 2 seconds, the standard display appears.
- or
- ▶ tap  until  appears in the cooking zone display.

5.7 Safety features

5.7.1 Child lock

The child lock prevents the appliance from being switched on accidentally.

- After switching on the appliance, the lock symbol  lights up in the operating panel display.

Permanently activating/deactivating the child lock

(see "6.2 Menu item 2: Child lock")

Deactivating the child lock for a cooking session

- ▶ Long press on the lock button .

- The standard display lights up and the operating panel is reactivated.

5.7.2 Residual heat indicator

If a cooking zone is still hot after switching off, there is a risk of burns or fire. While **H** is displayed for a cooking zone (residual heat indicator), do not touch the cooking zone or place any heat-sensitive objects on top of it.

- **H** is shown at 100% brightness: very high temperature.
- **H** is shown at 50% brightness: high temperature.

The display goes out after a sufficient cooling time (temperature < 55°C).

5.7.3 Safety shut-down

Cooktop extractor

The cooktop extractor switches to automatic mode after 120 min if there has been no input or changes to the power level.

Cooktops

Each cooking zone is automatically switched off after a predefined operating time in which the power level has not been changed. 3 levels are available to set the time until safety shut-down.

- Safety shut-down is preset to level 2.
- The level can be changed in the user menu.

Power levels	Safety shut-down after hrs:min.		
	Level 1	Level 2	Level 3
1	12:00	8:24	6:00
2	10:00	6:24	4:00
3	9:00	5:12	2:30
4	8:00	4:12	2:00
5	6:00	3:18	1:30
6	4:00	2:12	1:00
7	4:00	2:12	1:00
8	3:00	1:48	0:45
9	2:00	1:18	0:30
P	0:05	0:05	0:05

Tab. 5.8 Safety shut-down on the different power levels

Power level	Safety shut-down after hrs:min.		
	Level 1	Level 2	Level 3
	12:00	8:00	4:00

Tab. 5.9 Safety shut-down on the different heat retention levels

- ▶ Switch the cooking zone back on if you want to put the cooking zone back into operation.

5.7.4 Overheating protection

-  In the event of overheating, the cooktop power is reduced or the appliance is switched off completely.

The appliance is fitted with overheating protection. The overheating protection can be triggered if:

- cookware is heated up empty;
- oil or fat is heated on high power;
- a hot cooking zone is switched on again after a power cut.

Whilst the overheating protection is active, one of the following steps is taken:

- the activated power setting is switched back to the previous level;
- the power setting can no longer be switched on;
- the set power level is reduced;
- the cooktop switches off completely.

After a sufficient cooling period, the cooktop can be used again in full.

6 User menu

Certain functions can be set in the user menu.

- i** The menu can only be called up if all cooking zones and the cooktop extractor are inactive. In addition, there must be no residual heat.

Calling up the user menu

- ▶ Switch on the appliance by pressing the power button .
 - If start-up is successful, the standard display will appear in the operating panel.
- ▶ Long press on the multi-function display.
 - The menu is called up and the first menu item is displayed.

Navigating the user menu

- ▶ Tap the multi-function display.
 - The system moves to the next menu item.
 - The system automatically adopts and saves set values when you move to another menu item or close the menu.

Closing the user menu

- ▶ Long press on the multi-function display.
 - or
 - ▶ long press on the power button 
 - The menu is closed and the appliance is switched off.

User menu overview

Menu item/Description/Selection area	Factory setting
1 Volume of the acoustic signals (0-9)	4
2 Child lock (On/Off)	Off
3 Show filter status (reset filter service display)	
4 Duration of the automatic after-run function (10, 15, 20 min.)	20 min
5 Touch zone reaction speed (1 slow, 2 medium, 3 fast)	2
6 LED test	
7 Permanent pan size recognition	Off
8 Software/hardware version	
9 Safety shut-down (1 long, 2 medium, 3 short)	2
A Super simple mode	Off
0 Reset to factory settings	

Tab. 6.1 User menu overview

6.1 Menu item 1: volume of the acoustic signals

- i** Safety-relevant acoustic signals are always emitted with the volume at 100%.
- i** The acoustic signal when switching on or off is always set to at least volume level 4.
- i** The current set volume is shown in the rear, left-hand cooking zone display when the menu item is called up.

Setting the acoustic signal volume:

- ▶ Swipe  upwards or downwards until the required volume is reached.
- ▶ Move to another menu item or close the menu.

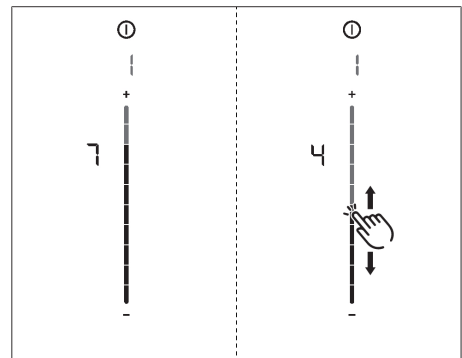



Fig. 6.1 Menu item 1: volume of the acoustic signals

6.2 Menu item 2: Child lock

- i** With menu item 2 the child lock can be permanently switched on or off. This setting is adopted for each new cooking session.

Permanently activating the child lock

- ▶ Tap the top slider segment .
 -  is displayed.
- ▶ Move to another menu item or close the menu.
 - The child lock is permanently activated.

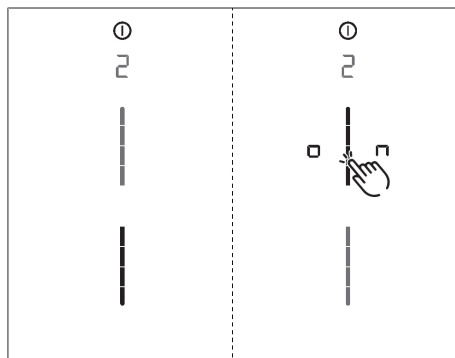



Fig. 6.2 Menu item 2: Child lock

Permanently deactivating the child lock

- ▶ Tap the bottom slider segment .
- ▶ Move to another menu item or close the menu.
- The child lock is permanently deactivated.

6.3 Menu item 3: Show filter status and reset filter service display

- i** If menu item 3 is called up, the filter status will be automatically shown (only in recirculation mode).

Resetting the filter service display

- ▶ Long press on the fan button .
- All slider elements are once again displayed at 100% brightness.
- The filter service indicator **F** is no longer displayed when the cooktop extractor is switched on.
- ▶ Move to another menu item or close the menu.

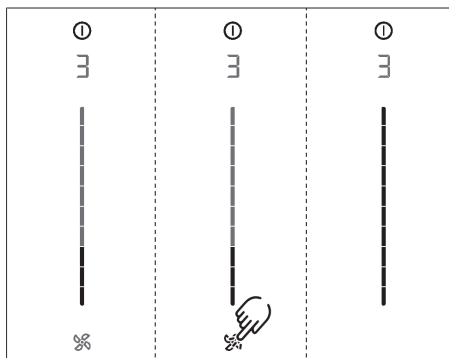

Fig. 6.3 Menu item 3: Filter status

6.4 Menu item 4: Duration of the automatic after-run function

- i** The duration of the automatic after-run function can be set using menu item 4.

There are three times to choose from:

- 20 minutes
- 15 minutes
- 10 minutes

The current duration is displayed for 2 seconds.

Selecting the duration of the automatic after-run function

- ▶ Tap the corresponding slider segment .
- ▶ Move to another menu item or close the menu.

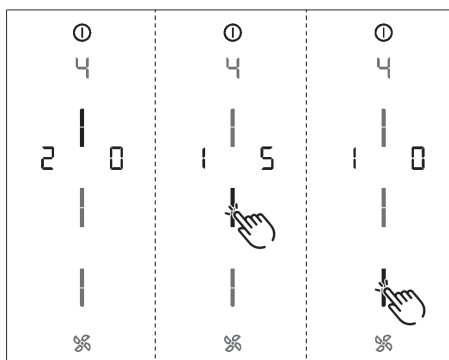



Fig. 6.4 Menu item 4: Duration of the automatic after-run function

6.5 Menu item 5: Touch zone reaction speed

i The reaction speed of the touch zones can be set using menu item 5.

- Reaction speed 1: slow
- Reaction speed 2: medium
- Reaction speed 3: fast
- The current reaction speed is displayed.

Selecting the reaction speed

- ▶ Tap the corresponding slider segment .
- ▶ Move to another menu item or close the menu.

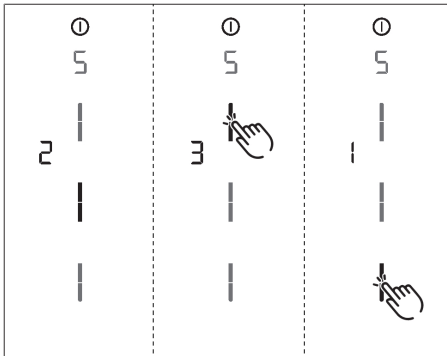



Fig. 6.5 Menu item 5: Reaction speed

6.6 Menu item 6: LED test

i With menu item 6 all LEDs in the individual touch zones can be tested to ensure that they are working.

Starting the LED test

- ▶ Tap the slider zone .
- All indicators are displayed at 50 % brightness.
- ▶ Tap any indicator you wish.
- The selected indicator will be displayed at 100% brightness for one second.
- Any other indicators can be tested by touch as required.

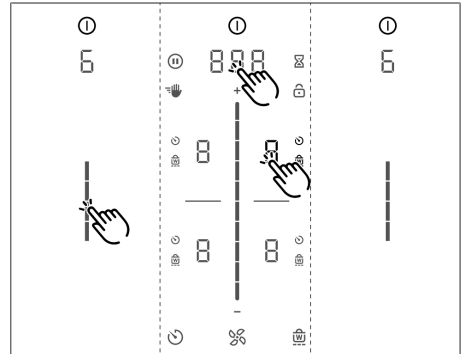

Fig. 6.6 Menu item 6: LED test

Ending the LED test

- The LED test will be automatically ended when there has been no activity for 5 seconds.



or

- ▶ Long press on the multi-function display.
- The LED test is ended.
- ▶ Move to another menu item or close the menu.

6.7 Menu item 7: Permanent pan size recognition

i With menu item 7 the permanent pan size recognition can be permanently switched on or off.

Activating permanent pan size recognition

- ▶ Tap the top slider segment .
- The pan size recognition symbol  is displayed on all cooking zones for one second.
-  is displayed.
- ▶ Move to another menu item or close the menu.

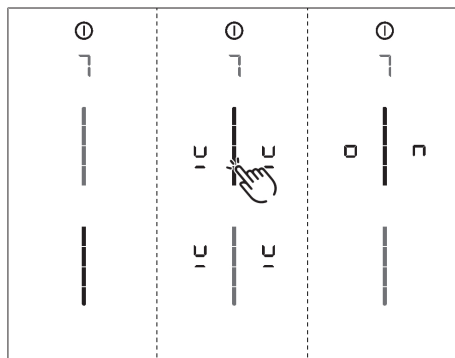



Fig. 6.7 Menu item 7: Permanent pan size recognition

Deactivating permanent pan size recognition

- ▶ Tap the bottom slider segment .
- ▶ Move to another menu item or close the menu.

6.8 Menu item 8: Show software/hardware version

- The software/hardware version is shown via the four 7-segment cooking zone indicators.
- ▶ Move to another menu item or close the menu.

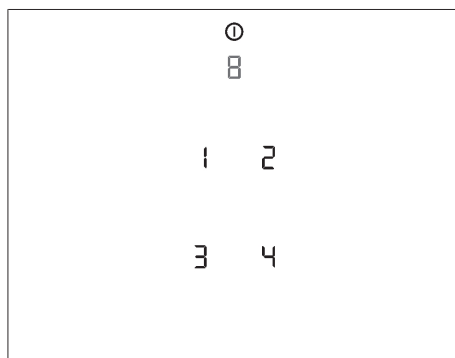

Fig. 6.8 Menu item 8: Software/hardware version

6.9 Menu item 9: Safety shut-down

- i** The time span (level) until automatic safety shut-down of the cooking zones can be selected using menu item 9.

- Level 1: long time span until automatic safety shut-down
- Level 2: medium time span until automatic safety shut-down
- Level 3: short time span until automatic safety shut-down

(see "5.7.3 Safety shut-down")

- The current level is displayed.

Selecting the level

- ▶ Tap the corresponding slider segment .
- ▶ Move to another menu item or close the menu.

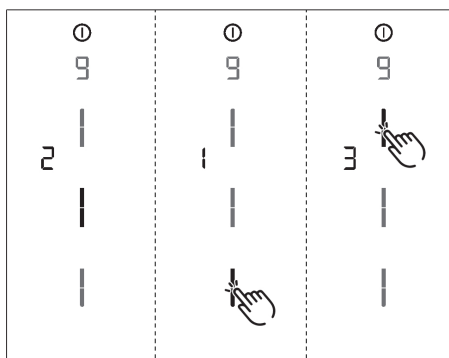

Fig. 6.9 Menu item 9: Safety shut-down

6.10 Menu item A: Super simple mode



- i** In super simple mode certain additional functions are deactivated and their indicators are faded out.

The following additional functions are deactivated in super simple mode:

- Cooking zone timer
- Short-time timer
- Cleaning lock
- Operating lock

- Heat retention function
- Pause function

Activating super simple mode

- ▶ Tap the top slider segment .
- The additional function indicators, which were deactivated, flash and fade.
-  is displayed.
- ▶ Move to another menu item or close the menu.
- The additional functions are permanently deactivated and are not displayed.

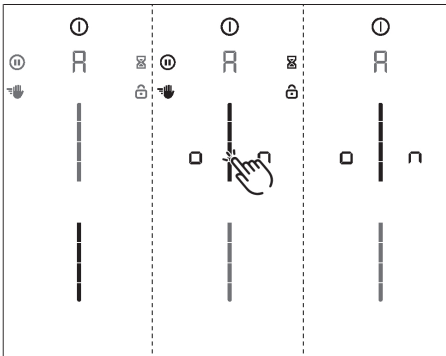

Fig. 6.10 Menu item A: Super simple mode

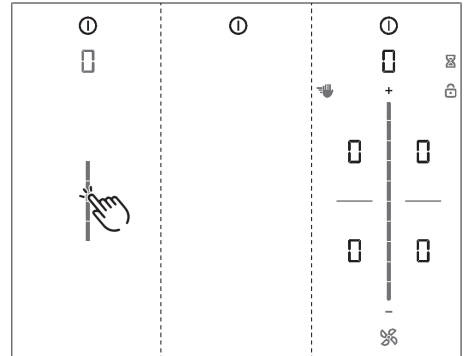



Fig. 6.11 Menu item 0: Factory settings

6.11 Menu item 0: Reset to factory settings

-  Menu item 0 enables all settings in the user menu to be reset to the factory settings.

Resetting to factory settings

- ▶ Long press on the slider zone .
- After resetting, the appliance is switched off.

7 Cleaning and maintenance

- ▶ Observe all safety and warning information (see "2 Safety").
- ▶ When conducting scheduled cleaning and maintenance, ensure that the cooktop and cooktop extractor are fully switched off and cooled so as to prevent injury.
 - Regular cleaning and maintenance ensures long service life of the product and optimal function.
- ▶ Adhere to the following cleaning and maintenance cycles.

Component	Cleaning cycles
Operating panel	Immediately after every soiling
Cooktop	Clean well immediately after soiling, using conventional detergents
Cooktop extractor	Weekly
Air inlet nozzle and stainless steel grease filter	<ul style="list-style-type: none"> ● After cooking very greasy dishes, but at least once a week ● If filter service indicator \bar{F} appears ● By hand or in the dishwasher (at 65°C max.) ● Clean the stainless steel surfaces in the polishing direction only!
Air guiding housing	Every 6 months or when replacing the activated charcoal filter
Activated charcoal filter (with recirculation only)	Replace if odours have built up, extraction power is dwindling or filter service indicator \bar{F} appears

Tab. 7.1 Cleaning cycles

7.1 Cleaning agents

- i** Due to the use of aggressive cleaning agents and abrasion caused by the pot bases the surface will become damaged and dark stains will occur.

To clean the cooktop, you need a special glass ceramic scraper and suitable cleaning agents.

- ▶ Never use steam cleaners, abrasive sponges, scouring pads or chemically aggressive cleaning agents (e.g. oven cleaner spray).
- ▶ Make sure that the cleaning agent does not contain any sand, soda, acids, lyes or chloride.

Cleaning agents for the air inlet nozzle and stainless steel grease filter

- ▶ Do not use any aggressive cleaning agents or agents containing acid or lye.

7.2 Cooktop and extractor care

- ▶ Never use the appliance as a work or storage surface.
- ▶ Do not push or pull cookware over the appliance.
- ▶ Always lift pots and pans.
- ▶ Keep the appliance clean.
- ▶ Remove any dirt immediately.
- ▶ Only use suitable cookware with the appliance.

7.3 Cleaning the cooktop

- i** When the cooktop extractor is in use the air inlet nozzle must be fitted so that no small or light objects such as fabric or paper cleaning cloths can be sucked in.

- ▶ Make sure that the cooktop is switched off.
- ▶ Wait until all cooking zones are cold.
- ▶ Remove all coarse dirt and food residues from the cooktop using a glass ceramic scraper.
- ▶ Apply the cleaning agent to the cold cooktop.
- ▶ Spread the cleaning agent using kitchen roll or a clean cloth.
- ▶ Wipe the cooktop clean with a damp cloth.
- ▶ Dry the cooktop with a clean cloth.

If the cooktop is hot:

- ▶ Remove stubborn residues of plastic, aluminium foil, sugar or sweet dishes from the hot cooking zone immediately using a glass ceramic scraper to prevent burning.

Heavy soiling

- ▶ Remove heavy soiling and marks (limescale marks, mother-of-pearl-like shiny marks) using cleaning products while the cooktop is still warm.
- ▶ Wipe off any food that boils over with a damp cloth.
- ▶ Remove any remaining dirt with the glass ceramic scraper.
- ▶ Always remove any seeds, crumbs or similar that fall onto the cooktop during cooking immediately to prevent the surface getting scratched.

Any changes in colour or glossy spots do not mean that the cooktop is damaged. They do not affect the functionality of the cooktop or the stability of the glass ceramic panel.

Changes in the colour of the cooktop are the result of residues which have not been removed and have burnt on.

Glossy spots are the result of wear by the pan base, especially if aluminium-based cookware or unsuitable cleaning agents are used. These are difficult to remove.

7.4 Cleaning the cooktop extractor

The air inlet nozzle and stainless steel grease filter absorb the greasy particles from cooking vapours.

- ▶ Make sure that the cooktop and cooktop extractor are switched off.
- ▶ Wait until the fan display shows .
- ▶ Clean the cooktop extractor in accordance with the cleaning cycles.
- ▶ Clean the surfaces of the extraction system using a soft, damp cloth, detergent or a mild window cleaning agent.
- ▶ Soften dried on dirt using a damp cloth (do not scrape it off!).

7.4.1 Removing the components

Removing the Pure air inlet nozzle

Prerequisite: the fan display shows .

- ▶ Reach into the access opening of the air inlet nozzle with your finger.
- ▶ Pull the air inlet nozzle up and out.

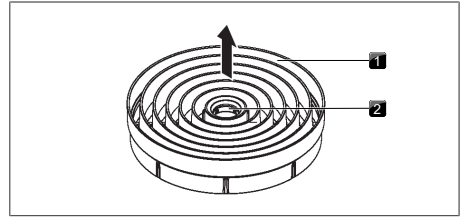

Fig. 7.1 Removing the air inlet nozzle

- [1] Air inlet nozzle
- [2] Access opening

Removing the stainless steel grease filter

- ▶ Take hold of the stainless steel grease filter by the handle.
- ▶ Pull the stainless steel grease filter up and out of the suction opening.

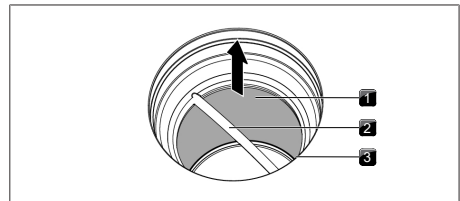



Fig. 7.2 Removing the stainless steel grease filter

- [1] Stainless steel grease filter
- [2] Handle
- [3] Inlet opening

7.4.2 Cleaning the air inlet nozzle and stainless steel grease filter

-  If the stainless steel grease filter can no longer be fully cleaned, it must be replaced (Warranty, technical service, spare parts, accessories).

Manual cleaning

- ▶ Use a cleaner and degreaser in one.
- ▶ Rinse the components with hot water.
- ▶ Clean the components with a soft brush.
- ▶ Rinse the components well after cleaning.

Cleaning in the dishwasher

- ▶ Remove coarse food residues from the components.
- ▶ Place the components in the dishwasher.
- ▶ No water should be able to gather in the components.
- ▶ Rinse the components with a rinsing program at a maximum temperature of 65°C.

i To prevent water from dripping into the appliance, it is recommendable to shake the nozzle well upon removal from the dishwasher and, if necessary, to dry it with a tea towel.

7.4.3 Fitting the components

Inserting the stainless steel grease filter

- ▶ Take hold of the stainless steel grease filter by the handle.
- ▶ Insert the stainless steel grease filter in the inlet opening. A lock is not provided or necessary.

Inserting the air inlet nozzle

- ▶ Insert the air inlet nozzle in the inlet opening.
- ▶ Make sure it is positioned correctly.

7.4.4 Removing liquids from the appliance

Any liquids that flow into the appliance through the inlet opening are caught by the stainless steel grease filter (up to 150 ml) and in the air guiding housing.

Do the following:

- ▶ Switch off the fan and deactivate the after-run function.
- ▶ Remove the air inlet nozzle and stainless steel grease filter.
- ▶ Empty the stainless steel grease filter.
- ▶ Check whether any liquid has gathered in the base of the air guiding housing.
- ▶ If necessary, wipe the liquid up from the housing base from above through the inlet opening using a sponge or cloth.
- ▶ Clean the air guiding housing.
- ▶ To dry the activated charcoal filter and duct parts respectively, switch on the cooktop extractor at a minimum power level of 5.

- After 120 minutes the cooktop extractor will automatically switch to the automatic after-run function.

7.5 Cleaning the air guiding housing

Grease particles and limescale residues from cooking vapours can settle on the surface of the air guiding housing. For this reason, regular cleaning is essential. The air guiding housing can be found on the bottom of the cooktop inside the floor unit.

Opening the air guiding housing

- ▶ Make sure that the cooktop and cooktop extractor are switched off.
- ▶ Wait until the fan display shows .
- ▶ Remove the air inlet nozzle and stainless steel grease filter.
- ▶ Inside the inlet opening pull the filter replacement cover out through the opening in the filter housing.
- ▶ Hold the housing base with one hand.
- ▶ Release the 6 locks around the edge of the base.
- ▶ Remove the housing base.
- ▶ Clean the air guiding housing and the housing base with a mild cleaning agent.

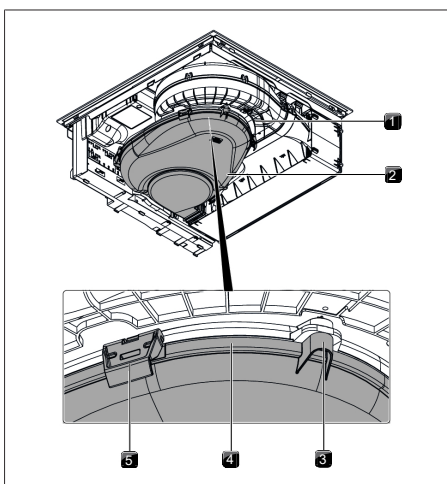

Fig. 7.3 Air guiding housing

- [1] Air guiding housing
- [2] Housing base
- [3] Spigot
- [4] Sealing groove
- [5] Lock

Closing the air guiding housing

- ▶ Position the housing base under the air guiding housing with the help of the 3 spigots.
- ▶ Push the housing base upwards into the sealing groove.
- ▶ Close the 6 locks.
- ▶ Check that the housing base is positioned correctly.
- ▶ Inside the inlet opening push the filter replacement cover until it comes to a stop in the filter housing opening.
- ▶ Check that the filter replacement cover is positioned correctly.
- ▶ Insert the stainless steel grease filter and the air inlet nozzle.

7.6 Replace the activated charcoal filter

An activated charcoal filter will only be fitted with the stainless steel grease filter if the cooktop extractor is used in recirculation mode. The activated charcoal filter absorbs cooking odours that arise during cooking. The activated charcoal filter must be replaced when the fan display shows F (Filter service indicator).

- ▶ Make sure that the cooktop and cooktop extractor are switched off.
- ▶ Wait until the fan display shows \square .

i You can obtain activated charcoal filters from your specialist supplier or from the BORA Shop via the website at <http://www.mybora.com>.

Removing the activated charcoal filter

- ▶ Remove the air inlet nozzle and stainless steel grease filter.
- ▶ Inside the inlet opening pull the filter replacement cover out through the opening in the filter housing.

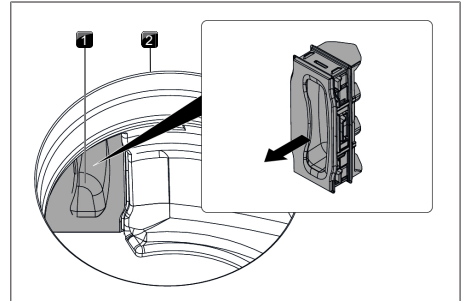

Fig. 7.4 Removing the filter replacement cover

- [1] Filter replacement cover
- [2] Inlet opening

- ▶ Take hold of the activated charcoal filter by the grip strap and pull it out as far as possible through the filter housing opening.

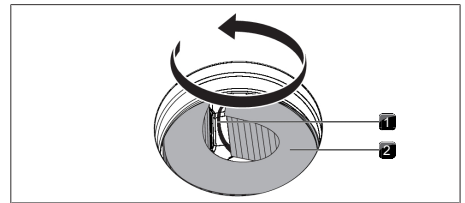

Fig. 7.5 Removing the activated charcoal filter from the filter housing

- [1] Grip strap
- [2] Activated charcoal filter

- ▶ Take hold of the end of the activated charcoal filter and pull upwards and towards the left until it is completely out of the inlet opening.

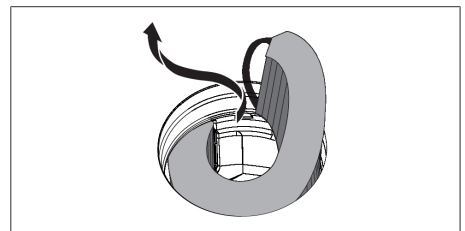

Fig. 7.6 Taking the activated charcoal filter out of the inlet opening

Inserting the activated charcoal filter

- ▶ Remove the packaging from the activated charcoal filter.
- ▶ Position the activated charcoal filter correctly with the help of the printed symbols (arrow left, grip strap right).
- ▶ Hold the activated charcoal filter at both ends.
- ▶ Bend the activated charcoal filter into a cylindrical shape so that both ends of the filter are opposite each other.

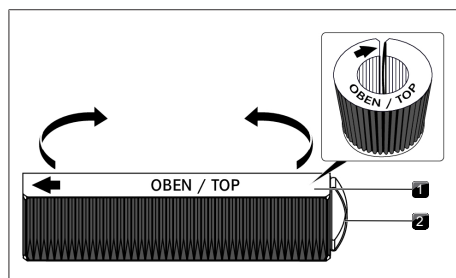

Fig. 7.7 Activated charcoal filter

- [1] Activated charcoal filter
- [2] Grip strap

- ▶ Tilt the activated charcoal filter towards you slightly and insert it through the inlet opening.
- ▶ Guide the left end of the filter into the opening in the filter housing.

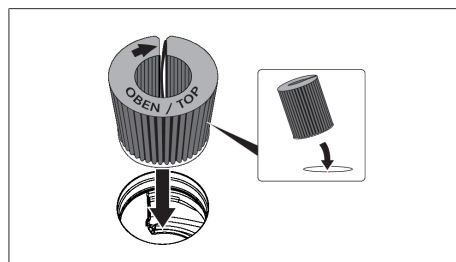

Fig. 7.8 Inserting the activated charcoal filter through the vent opening

- ▶ Push the activated charcoal filter into the filter housing until it will go no further (to do this, you can place one finger between the slats and gradually push the filter into the housing).

- The end position of the activated charcoal filter is reached when the filter has been fully pushed inside the filter housing.

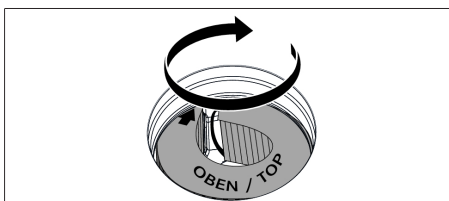

Fig. 7.9 Placing the activated charcoal filter in the end position

- ▶ Inside the inlet opening push the filter replacement cover until it comes to a stop in the filter housing opening.
- ▶ Check that the filter replacement cover is positioned correctly.

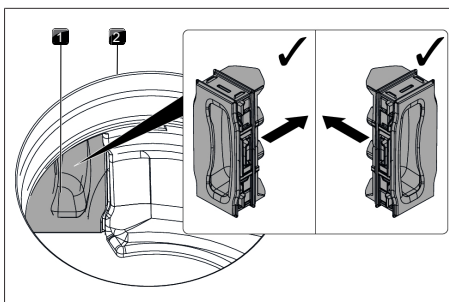

Fig. 7.10 Inserting the filter replacement cover







- [1] Filter replacement cover
- [2] Inlet opening

- ▶ Insert the stainless steel grease filter and the air inlet nozzle.
- ▶ Reset the filter service display (see "6.3 Menu item 3: Show filter status and reset filter service display").

8 Troubleshooting

i You can often resolve faults and errors that can occur in day-to-day operation yourself. That way you save time and money as you don't need to call out customer services.

► Observe all safety and warning information (see "2 Safety").

Operating situation	Cause	Remedy
The appliance cannot be switched on.	The fuse/automatic circuit breaker of the electrical wiring system in the apartment and/or house is defective.	Replace the fuse. Switch the automatic circuit breaker back on.
	The fuse/automatic circuit breaker trips several times.	BORA Contact the Service Team.
	The power supply is disconnected.	Have a specialist electrician inspect the power supply.
Build-up of odours when new cooktop extractor is in operation	This is normal on brand-new appliances	Odours stop forming after a few operating hours
 is displayed in the cooking zone display	No or unsuitable cookware on the cooking zone	Use suitable cookware. Select the cookware size depending on the cooking zone
The lock symbol is brighter than the other indicators	The child lock is activated	Switching off the child lock
A cooking zone or the entire cooktop switches off automatically.	The maximum cooking zone operating time has been exceeded.	Put the cooking zone back into operation.
The power setting is automatically shut off prematurely	The overheating protection has tripped	see "5.7.4 Overheating protection"
The cooktop cooling fan continues to run when the cooktop has been switched off	The cooling fan runs until the cooktop has cooled	Wait until the cooling fan switches off automatically
The extraction performance of the cooktop extractor has decreased	The grease filter is extremely dirty	Clean or replace the grease filter
	The activated charcoal filter is heavily soiled (recirculation only)	Replace the activated charcoal filter
	There is an object in the air guiding housing (e.g. cleaning cloth)	Remove the object
 is shown in the fan display	Use of a phase-separating window contact switch	Open the window
	The fan is defective or a duct connection has become loose	BORA Contact the Service Team
 is shown in the cooking zone	The overheating protection has tripped	see "5.7.4 Overheating protection"
 is shown.  in the fan display,  in the rear cooking zones	Object on the operating panel	Remove the object from the operating panel
	The operating panel is dirty	Clean the operating panel

Operating situation	Cause	Remedy
E \square is shown in the fan display	Use of a phase-separating window contact switch	Open the window
	The fan is defective or a duct connection has become loose	BORA Contact the Service Team
F is shown in the fan display (recirculation only).	End of activated charcoal filter service life reached.	Insert a new activated charcoal filter (see "7.6 Replace the activated charcoal filter").

Tab. 8.1 Troubleshooting

Faults and errors not covered:

- ▶ Switch off the appliance.
- ▶ Contact the BORA Service Team Team (see see "11 Warranty, technical service, spare parts, accessories") and enter the error number displayed and the appliance type.

9 Installation

- ▶ Follow the enclosed manufacturer's information.
- ▶ Observe all safety and warning information (see "2 Safety").

9.1 General installation instructions

- i** The power supply cable must be provided by the customer.
- i** The appliance must not be installed above cooling devices, dishwashers, stoves, ovens, washing machines or dryers.
- i** The contact surface of the worktops and wall sealing strips must be made of a heat-resistant material (up to approx. 100°C).
- i** Worktop cut-outs must be moisture-sealed using suitable means and, where necessary, fitted with a thermal insulator.
- i** The integrated cooktop extractor must not be used with other cooktops.

General installation instructions for cooktops

- ▶ Make sure that the area below the cooktop has a sufficient air supply.
- i** To ensure that the cooktops perform optimally at all times, there must be sufficient ventilation beneath the cooktops.
- i** The performance of the cooktops is affected or the cooktops overheat if the warm air beneath the cooktops cannot escape.
- i** In the event of overheating, the cooktop power is reduced or the appliance is switched off completely.
- i** If cable protection (false floor) is planned beneath the appliance, this must be fitted so it does not obstruct ventilation.

9.1.1 Simultaneous operation of the cooktop extractor in the exhaust air mode and a fireplace dependent upon the air supply in the room

- i** National and regional laws and regulations must be observed with regard to the exhaust duct design.
- i** A sufficient air supply must be ensured.

Fireplaces that depend on the air in the room (e.g. gas, oil, wood or coal-fired heaters, continuous-flow water heaters, instantaneous water heaters) draw in air from the room in which they are installed and release the exhaust fumes into the outside air via an exhaust system (e.g. chimney).

If the cooktop extractor is used in exhaust air mode, it draws in air from the room in which it is installed as well as from neighbouring rooms. Without sufficient air, there will be a drop in air pressure. Toxic gases could be drawn out of the chimney or extraction ducting and back into the room.

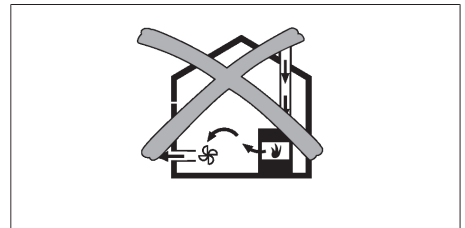

Fig. 9.1 Exhaust air installation – not permitted

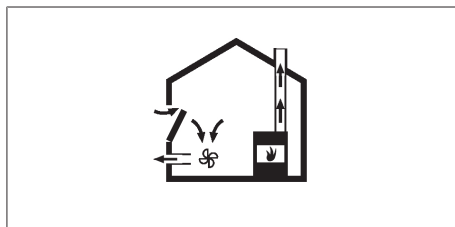

Fig. 9.2 Exhaust air installation – correct

- ▶ If simultaneously operating both a fireplace and the cooktop extractor in the same room, ensure that:
 - the maximum low pressure is 4 Pa (4×10^{-5} bar);
 - a safety device (e.g. window contact switch, low pressure warning device) is used to ensure that a sufficient supply of fresh air is guaranteed;
 - the exhaust air is not channelled into a chimney that is used for exhaust gases of appliances operated with gas or other combustibles;
 - the installation is checked and approved by an authorised certified engineer (e.g. heating engineer).

i If the cooktop extractor is used exclusively in recirculation mode, operation with an open fireplace is possible without any additional safety measures.

9.2 Scope of delivery

Scope of delivery	Quantity
Cooktop with integrated cooktop extractor	1
Air inlet nozzle	1
Stainless steel grease filter	1
Operating and installation instructions	1
Sealing tape	1
Height adjustment plate set	1
Bag containing various small parts for assembly	1
Additional scope of delivery PURSU	
Activated charcoal filter	1
Template for back panel cut-out	1

Tab. 9.1 Scope of delivery

Checking the scope of delivery

- ▶ Make sure the delivery is complete and check it for damage.

- ▶ Immediately inform the BORA Service Team if parts are missing or damaged.
- ▶ Do not under any circumstances install parts which are damaged.
- ▶ Dispose of transport packaging in the proper manner (see "10 Decommissioning, disassembly and disposal").

9.3 Tools and aids

The following tools, among others, are required to correctly install the cooktop:

- Jigsaw or handsaw
- Template for cut-out on back panel (recirculation only, included in scope of delivery)
- size 20 Torx screwdriver key
- black, heat-resistant silicone sealant

9.4 Assembly instructions

9.4.1 Installation clearances

- ▶ Observe the required clearance around the worktop cut-out.

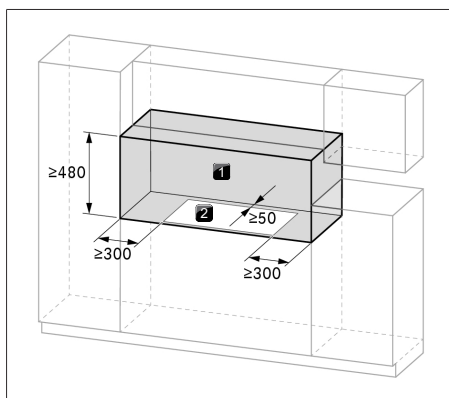

Fig. 9.3 Required clearance

- [1] Required clearance
- [2] Worktop cut-out

9.4.2 Minimum unit dimensions for S Pure (PURSA, PURSU)

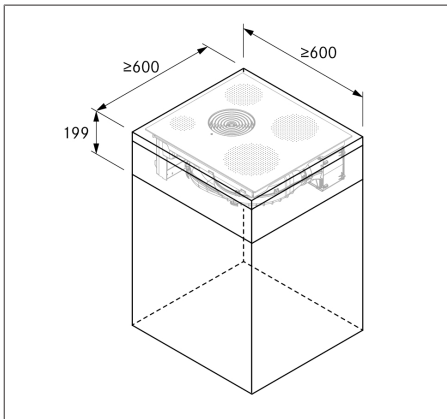

Fig. 9.4 Minimum unit dimensions for S Pure

9.5 Worktop cut-out

i The minimum measurement of 50 mm from the front edge of the worktop to the worktop cut-out is a recommendation from BORA.

- ▶ Create the worktop cut-out taking into account the specified cut-out dimensions.
- ▶ Make sure that the cut surfaces of the worktops are properly sealed.
- ▶ Comply with the instructions of the worktop manufacturer.

9.5.1 S Pure cut-out dimensions

S Pure surface mounting (PURSA, PURSU)

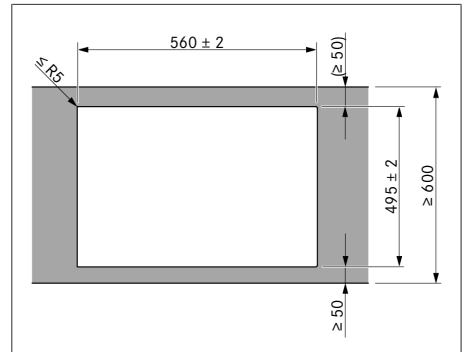

Fig. 9.5 Cut-out dimensions for surface mounting

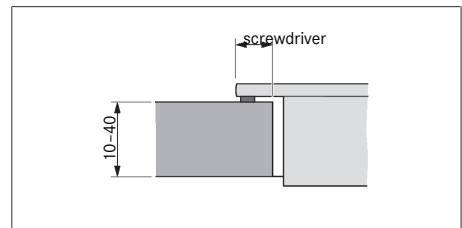

Fig. 9.6 Overlay dimensions for surface mounting

S Pure flush installation (PURSA, PURSU)

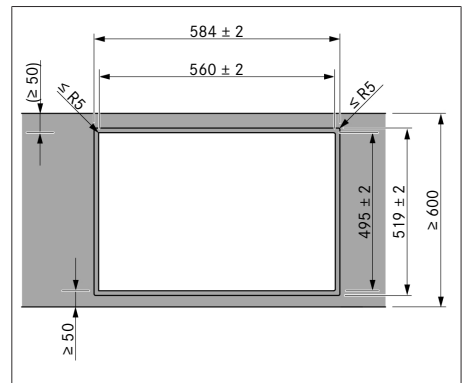

Fig. 9.7 Cut-out dimensions for flush installation

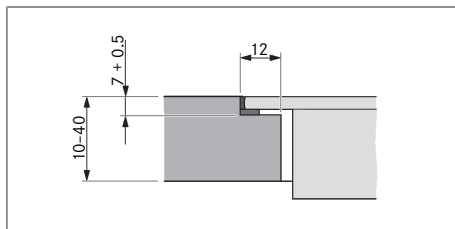

Fig. 9.8 Rebate dimensions for flush installation

9.6 Installing the appliance in exhaust air mode

- i** National and regional laws and regulations must be observed with regard to the exhaust duct design.
- i** A sufficient air supply must be ensured.
- i** The exhaust air must be directed to the outside by appropriate exhaust air ducts.
- i** The minimum cross section of the exhaust air duct must be 176 mm^2 which equates to a round pipe with a diameter of 150 mm or the BORA Ecotube duct system.
- i** As a general rule, with the built-in fan, a length of duct of up to 6 metres with six 90° bends, 8 metres with four 90° bends or 10 metres with two 90° bends can be installed.
- i** Not compatible with BORA Universal fans.
- i** Planning instructions for the installation of the exhaust air ducts are provided in the BORA planning guide.

9.6.1 Preparing kitchen units for the exhaust air model

- Cross bars on the kitchen unit in the area of the worktop cut-out may need to be removed.
- In the case of thin worktops, there must be a sufficiently rigid support plate on the unit.

- The back panel of the floor unit must be adapted for the exhaust air duct.
- A minimum clearance of 120 mm between the back panel of the unit and an adjacent kitchen unit or room wall must be observed for the air duct.
- No false floor is necessary below the cooktop. If cable protection (false floor) is planned, the following must be taken into account:
 - It must be fitted in such a way that it can be removed from below for maintenance work.
 - To ensure sufficient cooktop ventilation, a minimum distance of 15 mm to the bottom edge of the cooktop is to be observed.
- The drawers and/or shelves in the floor unit must be removable.
- For correct installation, the drawers of the floor unit must be shortened depending on the installation situation.

9.6.2 Installation dimensions

Adjusting the back panel of the unit

- ▶ Before installation, check the suitability of the floor unit with regard to the necessary installation dimensions for the appliance and the planned duct system.
- ▶ If necessary, adjust the position of the back panel according to the required installation dimensions.

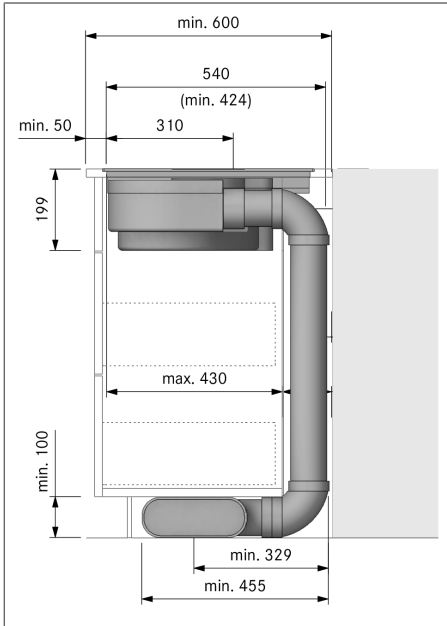

Fig. 9.9 Installation dimensions for exhaust air, worktop depth 600 mm

9.6.3 Preparing the cooktop

Attaching the sealing tape

- ▶ In the case of surface mounting, attach the enclosed sealing tape around the outer edges of the underside of the cooktop. Do not leave any gaps.
- ▶ In the case of flush installation, attach the sealing tape to the horizontal cutting edge in the worktop cut-out, even if you are sealing the cooktop with a silicone sealing compound or similar.

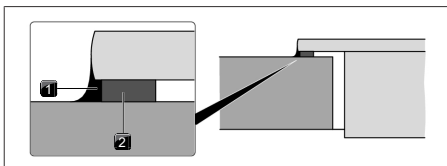

Fig. 9.10 Sealing tape in the case of surface mounting

- [1] Black, heat-resistant silicone sealant
- [2] Sealing tape

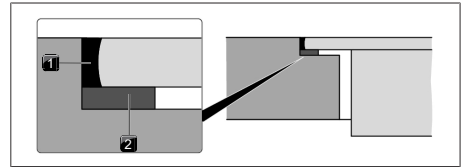

Fig. 9.11 Sealing tape in the case of flush installation

- [1] Black, heat-resistant silicone sealant
- [2] Sealing tape

9.6.4 Inserting the cooktop

- ▶ Before inserting the cooktop, remove the air inlet nozzle and the stainless steel grease filter.
- ▶ Use the inlet opening as a handle during insertion.
- ▶ Keep the cooktop straight as you lift it into the worktop cut-out.
- ▶ Insert the cooktop into the centre of the worktop cut-out.
- ▶ Precisely align the cooktop.

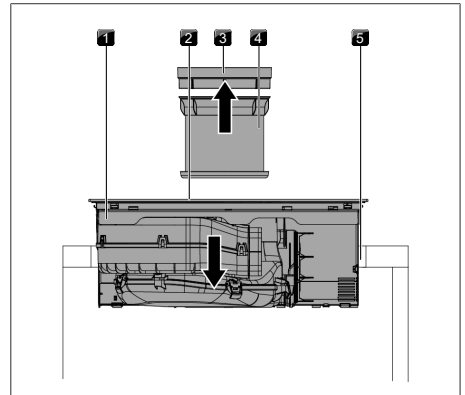

Fig. 9.12 Inserting the cooktop

- [1] Cooktop
- [2] Inlet opening
- [3] Air inlet nozzle
- [4] Stainless steel grease filter
- [5] Worktop cut-out

- ▶ When aligning the cooktop, ensure that the holding clamps hold the cooktop in the worktop.

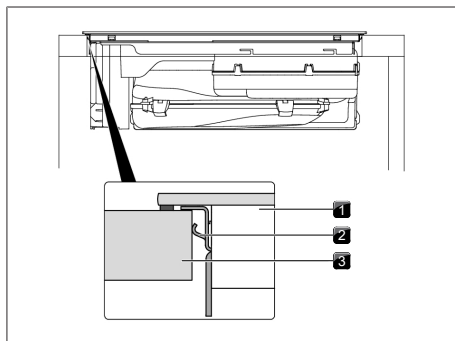

Fig. 9.13 Securing the cooktop in the middle

- [1] Cooktop
- [2] Holding clamp
- [3] Worktop

- i** Make sure that the cooktop sealing tape is flat against the worktop in the case of surface mounting.
- i** Make sure that the cooktop sealing tape is well sealed all the way round in the case of flush installation.

Height adjustment plates for flush installation (optional)

- The height adjustment plates are self-adhesive to prevent slipping during installation.
- ▶ If applicable, insert the height adjustment plates.
- ▶ Place the height adjustment plates next to the sealing tape.

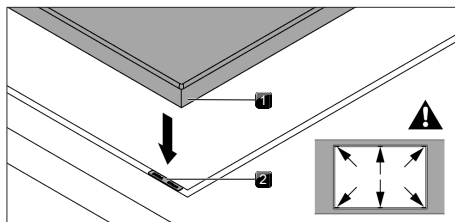

Fig. 9.14 Positioning the height adjustment plates

- [1] Cooktop
- [2] Height adjustment plate

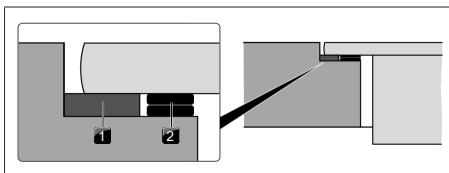

Fig. 9.15 Height adjustment plates

- [1] Sealing tape
- [2] Height adjustment plate

9.6.5 Connecting the appliance to the duct system

- i** The duct system must be fitted to the appliance free of load and with the power supply switched off.
- i** For correct installation, the drawers of the floor unit must be shortened depending on the installation situation.
- i** When attaching the seals, ensure that an airtight seal is created with the connecting duct piece when the seals are compressed.

- ▶ Use only BORA Ecotube duct parts.
- ▶ Do not use flexible or fabric hoses.
- ▶ Pull the seal onto the exhaust opening on the appliance. The seal will need to be stretched slightly.
- ▶ Push the duct part to be connected with the coupling onto the exhaust opening with the seal.
- ▶ Ensure that the seal is not displaced.

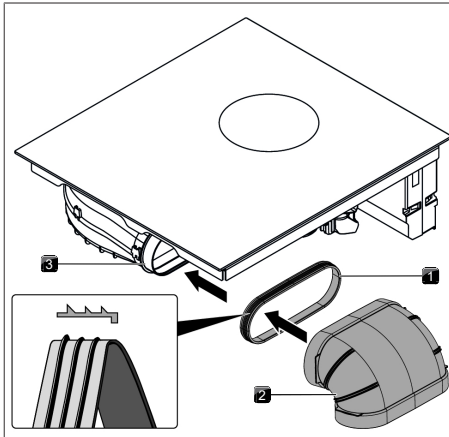

Fig. 9.16 Connecting the duct system

- [1] Seal
- [2] Duct part
- [3] Exhaust opening

9.7 Installing the appliance in recirculation mode

9.7.1 Recirculation of air from the kitchen unit

In the case of recirculation systems, a return flow aperture must be provided in the kitchen unit to guide the clean recirculated air out of the unit and back into the room. The return flow aperture can be created above a shortened plinth. A slatted plinth with at least the minimum opening cross-section can also be used.

- ▶ Decrease the height of the plinth panel or create corresponding openings in the plinth.
- ▶ The cross-section of the return flow aperture must be $\geq 500 \text{ cm}^2$ for each cooktop extractor.

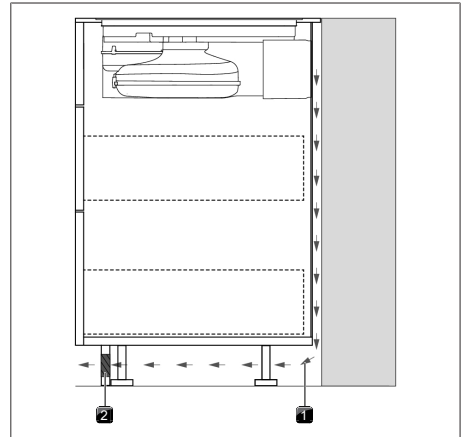

Fig. 9.17 Return flow aperture in the plinth area

- [1] Return flow of recirculated air
- [2] Return flow aperture in the plinth (total cross-section of the aperture $\geq 500 \text{ cm}^2$)

9.7.2 Installation variants A and B for recirculation appliances

There are 2 installation variants for recirculation appliances: A and B

A: floor unit with continuous back panel

The recirculated air is guided through the connection with the back wall of the air purification box directly behind the back panel of the unit. The recirculated air goes back in to the room through the return flow aperture.

For installation purposes, this means that:

- No false floor is necessary below the cooktop.
- There must be a cut-out in the back panel.

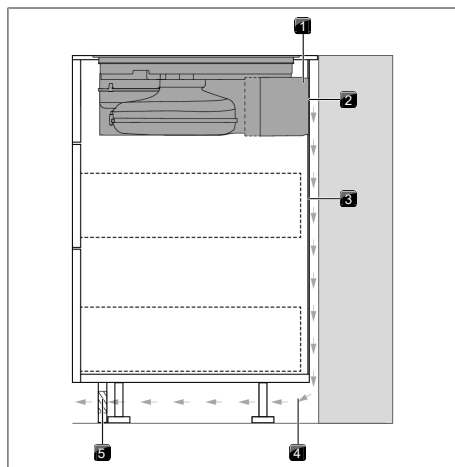

Fig. 9.18 Installation variant with continuous back panel

- [1] Air purification box
- [2] Connection with the back panel
- [3] Continuous back panel in the unit
- [4] Return flow of recirculated air
- [5] Return flow aperture

B: floor unit with false floor under the cooktop

The recirculated air is blown into the free space between the worktop and the false floor (the air purification box does not connect with the back panel). The recirculated air goes behind the back panel of the unit and through the return flow aperture back into the room.

For installation purposes, this means that:

- a false floor is necessary below the cooktop.
- There does not need to be a cut-out in the back panel of the unit.

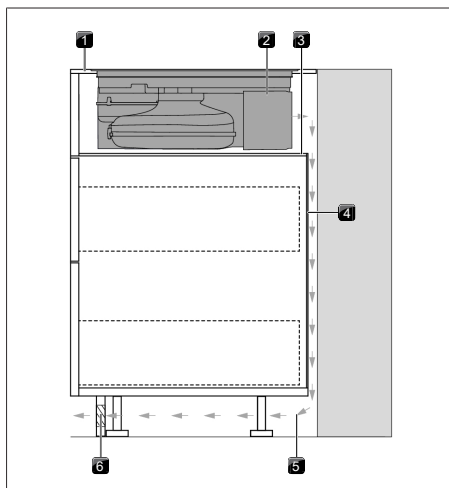

Fig. 9.19 Installation variant with false floor

- [1] Worktop
- [2] Air purification box
- [3] False floor
- [4] Back panel of unit
- [5] Return flow of recirculated air
- [6] Return flow aperture

9.7.3 Preparing the kitchen unit for installation variant A

- Cross bars on the kitchen unit in the area of the worktop cut-out may need to be removed.
- In the case of thin worktops, there must be a sufficiently rigid support plate on the unit.
- The floor unit must have a continuous back panel so that the recirculated air is not directed into the front furniture body compartment.
- There must be a cut-out in the back panel.
- A minimum clearance of 25 mm between the back panel of the unit and an adjacent kitchen unit or room wall must be observed for the return flow of the recirculation air.
- No false floor is necessary below the cooktop. If cable protection (false floor) is planned, the following must be taken into account:
 - it must be fitted in such a way that it can be removed for maintenance work.

- To ensure sufficient cooktop ventilation, a minimum distance of 15 mm to the bottom edge of the cooktop is to be observed.
- The drawers and/or shelves in the floor unit must be removable.
- For correct installation, the drawers of the floor unit must be shortened depending on the installation situation.

9.7.4 Installation dimensions for installation variant A

Adjusting the back panel of the unit

- ▶ Adapt the back panel according to the required installation dimensions.
- ▶ If necessary, move the back panel.
- ▶ If necessary, extend the height of the back panel so that the unit is closed to the front.

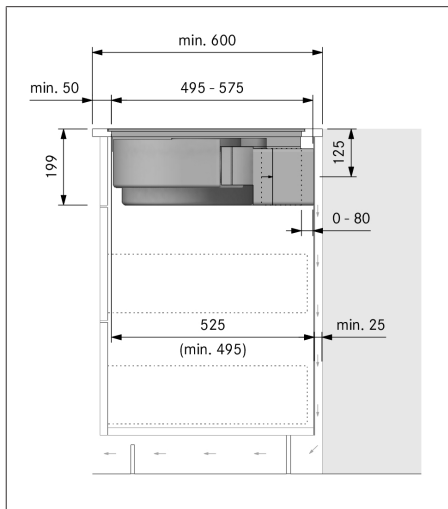

Fig. 9.20 Installation dimensions in the case of recirculated air, installation variant A

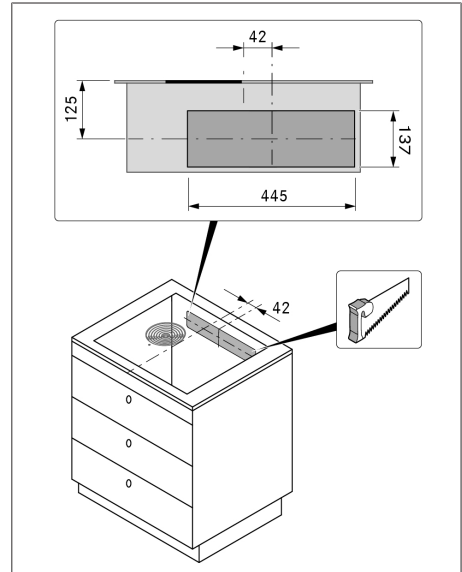

Fig. 9.21 Back panel cut-out

- ▶ Position the template on the back panel of the unit with the help of the markings and instructions.
- ▶ Mark out the back panel cut-out.
- ▶ Cut out the back panel cut-out with a saw.

i Flush and surface mounting options must be taken into account when positioning the template. 125 mm from top edge of the cooktop to centre of cut-out.

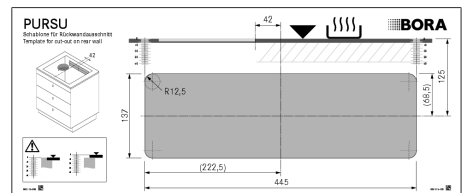

Fig. 9.22 Template for back panel cut-out

9.7.5 Preparing the kitchen unit for installation variant B

- Cross bars on the kitchen unit in the area of the worktop cut-out may need to be removed.
- In the case of thin worktops, there must be a sufficiently rigid support plate on the unit.
- A false floor must be provided for under the cooktop:
 - it must be fitted in such a way that it can be removed for maintenance work.
 - To ensure sufficient cooktop ventilation, a minimum distance of 15 mm to the bottom edge of the cooktop is to be observed.
- The back panel of the unit must be flush with the false floor so that the recirculating air is not directed into the front of the unit.
- A minimum clearance of 25 mm between the back panel of the unit and an adjacent kitchen unit or room wall must be observed for the return flow of the recirculation air.
- The drawers and/or shelves in the floor unit must be removable.
- For correct installation, the drawers of the floor unit must be shortened depending on the installation situation.

9.7.6 Installation dimensions for installation variant B

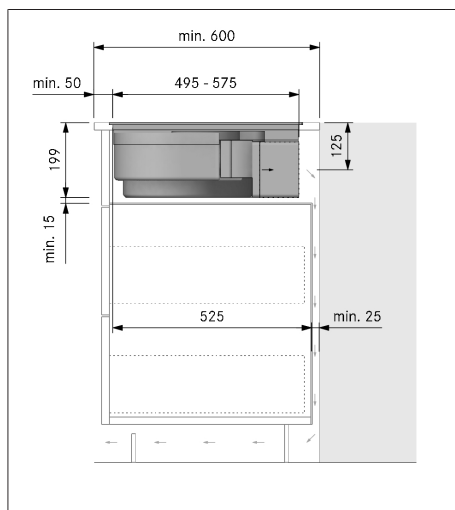

Fig. 9.23 Installation dimensions for recirculation installation variant B, depth of worktop 600 mm

Adjusting the back panel of the unit

- ▶ Adapt the back panel according to the required installation dimensions.
- ▶ If necessary, move the back panel.
- ▶ Adjust the height of the back panel to the false floor so that they are flush with one another.

9.7.7 Preparing the cooktop

Attaching the sealing tape

- ▶ In the case of surface mounting, attach the enclosed sealing tape around the outer edges of the underside of the cooktop. Do not leave any gaps.
- ▶ In the case of flush installation, attach the sealing tape to the horizontal cutting edge in the worktop cut-out, even if you are sealing the cooktop with a silicone sealing compound or similar.

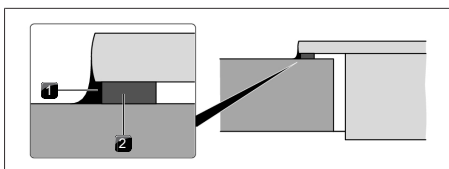

Fig. 9.24 Sealing tape in the case of surface mounting

- [1] Black, heat-resistant silicone sealant
- [2] Sealing tape

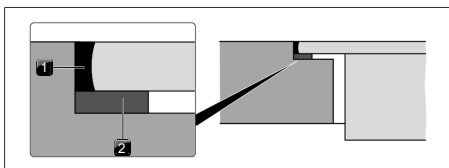

Fig. 9.25 Sealing tape in the case of flush installation

- [1] Black, heat-resistant silicone sealant
- [2] Sealing tape

9.7.8 Inserting the cooktop – recirculation

- ▶ Before inserting the cooktop, remove the air inlet nozzle and the stainless steel grease filter.
- ▶ Remove the protective film from the adhesive tape on the front of the telescopic pull-out.

- ▶ Use the inlet opening as a handle during insertion.
- ▶ Keep the cooktop straight as you lift it into the worktop cut-out.
- ▶ Insert the cooktop into the centre of the worktop cut-out.
- ▶ Precisely align the cooktop.

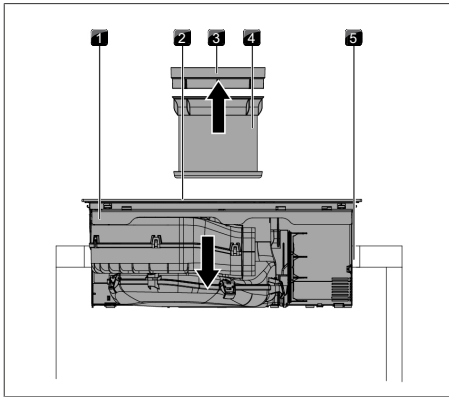

Fig. 9.26 Inserting the cooktop

- [1] Cooktop
- [2] Inlet opening
- [3] Air inlet nozzle
- [4] Stainless steel grease filter
- [5] Worktop cut-out

- ▶ When aligning the cooktop, ensure that the holding clamps hold the cooktop in the worktop.

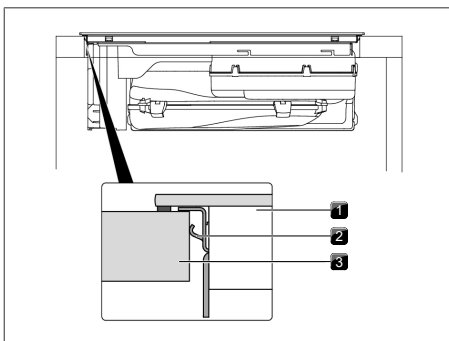

Fig. 9.27 Securing the cooktop

- [1] Cooktop
- [2] Holding clamp
- [3] Worktop

i Make sure that the cooktop sealing tape is flat against the worktop in the case of surface mounting.

i Make sure that the cooktop sealing tape is well sealed all the way round in the case of flush installation.

Height adjustment plates for flush installation (optional)

- The height adjustment plates are self-adhesive to prevent slipping during installation.
- ▶ If applicable, insert the height adjustment plates.
- ▶ Place the height adjustment plates next to the sealing tape.

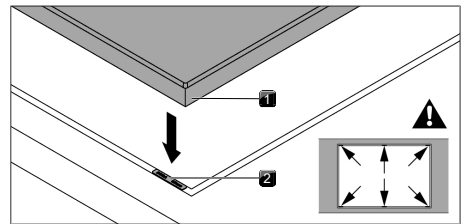

Fig. 9.28 Inserting height adjustment plates

- [1] Cooktop
- [2] Height adjustment plate

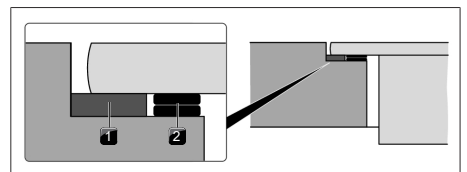

Fig. 9.29 Height adjustment plates

- [1] Sealing tape
- [2] Height adjustment plate

9.7.9 Making a connection with the back panel in installation variant A

- ▶ Push the telescopic pull-out until it is tight up against the back panel of the unit.
- With the telescopic pull-out the distance to the back panel of the unit can be flexibly bridged.
- ▶ Check that the telescopic pull-out fits accurately, is flush with the cut-out on the back panel of the unit and closes it off.
- ▶ Secure the telescopic pull-out to the back panel of the unit using the adhesive tape.

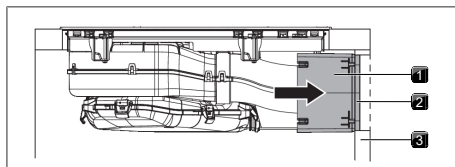

Fig. 9.30 Making a connection with the back panel

- [1] Telescopic pull-out
- [2] Adhesive tape
- [3] Back panel of unit

9.7.10 Inserting the activated charcoal filter

i To remove the filter see “8.6 Changing the activated charcoal filter”

- ▶ Inside the inlet opening pull the filter replacement cover out through the opening in the filter housing.

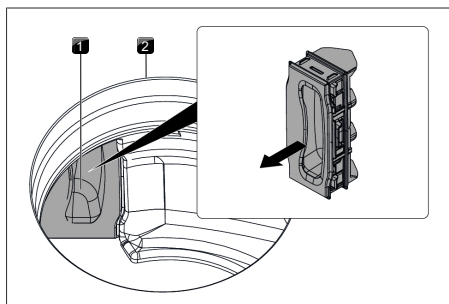

Fig. 9.31 Remove the filter replacement cover

- [1] Filter replacement cover
- [2] Inlet opening

- ▶ Remove the packaging from the activated charcoal filter.
- ▶ Position the activated charcoal filter correctly with the help of the printed symbols (arrow left, grip strap right).
- ▶ Hold the activated charcoal filter at both ends.
- ▶ Bend the activated charcoal filter into a cylindrical shape so that both ends of the filter are opposite each other.

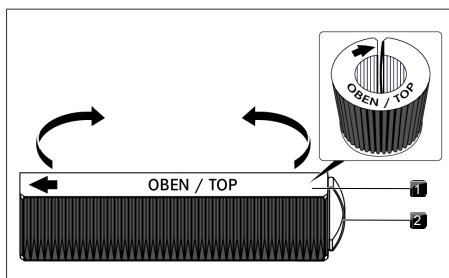

Fig. 9.32 Activated charcoal filter

- [1] Activated charcoal filter
- [2] Grip strap

- ▶ Tilt the activated charcoal filter towards you slightly and insert it through the inlet opening.
- ▶ Guide the left end of the filter into the opening in the filter housing.

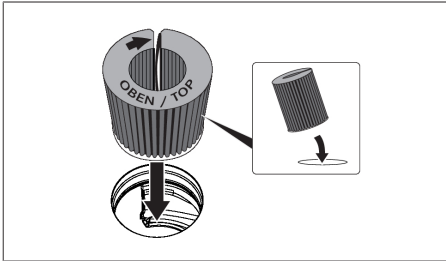

Fig. 9.33 Inserting the activated charcoal filter through the vent opening

- ▶ Push the activated charcoal filter into the filter housing until it will go no further (to do this, you can place one finger between the slats and gradually push the filter into the housing).
- The end position of the activated charcoal filter is reached when the filter has been fully pushed inside the filter housing.

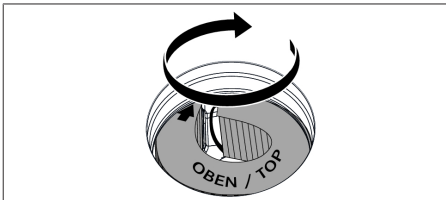

Fig. 9.34 Placing the activated charcoal filter in the end position

- ▶ Inside the inlet opening push the filter replacement cover until it comes to a stop in the filter housing opening.
- ▶ Check that the filter replacement cover is positioned correctly.

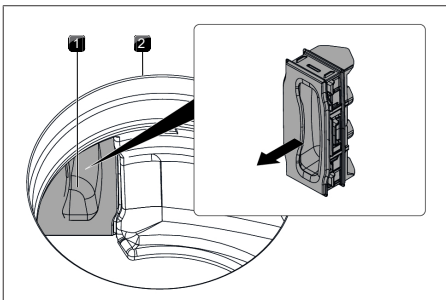

Fig. 9.35 Remove the filter replacement cover

- [1] Filter replacement cover
- [2] Inlet opening

9.8 Connecting the power supply

- ▶ Observe all safety and warning information (see "2 Safety").

i Assembly, installation and commissioning must always occur in line with national laws, regulations and standards. The work must be performed by qualified specialists who know and comply with the additional regulations of the local energy supply companies.

i Connections via plug-in contacts (Schuko plugs) are not permitted.

i 1-phase connection. The appliance complies with the requirements of IEC 61000-3-12.

- ▶ Open the 5 suction chamber locks.

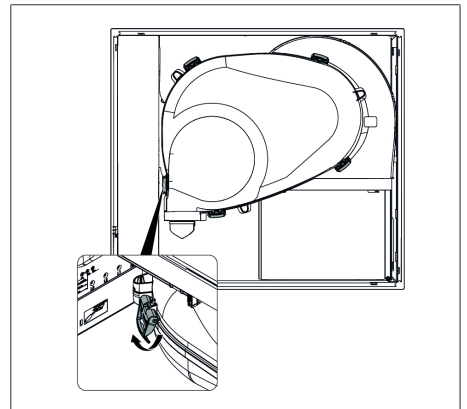

Fig. 9.36 Suction chamber locks

- ▶ Switch off the main switch/automatic circuit breaker before connecting the cooktop.
- ▶ Secure the main switch/automatic circuit breaker against being switched back on without permission.
- ▶ Make sure the power to the appliance is disconnected.

- ▶ Connect the cooktop exclusively via a fixed connection to an H 05 VV-F power supply cable with corresponding minimum cross-section.

Connection	Fuse protection	Minimum cross-section
Three-phase connection	3 x 16 A	2.5 mm ²
Two-phase connection	2 x 16 A	2.5 mm ²
One-phase connection	1 x 32 A	4 mm ²

Tab. 9.2 Fuse protection and minimum cross-section

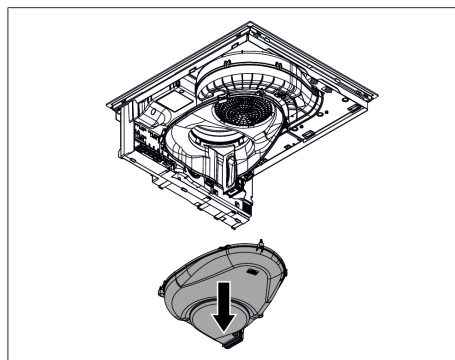

Fig. 9.37 Removing the bottom of the suction chamber

- ▶ Connect the power supply cable to the power supply of the appliance in accordance with the relevant connection diagram (see Fig. Connection diagram or underside of appliance).
- ▶ For a single-phase or two-phase connection, connect the relevant contacts using the bridge provided (in scope of delivery).
- ▶ Secure the connection cable with the strain relief clamp (in scope of delivery).
- ▶ Close the power supply housing with the power supply cover (in scope of delivery).
- ▶ Lay the connection cable along the mounting eyes with the help of the cable ties (in scope of delivery).
- ▶ Ensure that the cable is not trapped or damaged and is not able to come into contact with any hot areas on the cooktop.
- ▶ Check that installation has been carried out correctly.

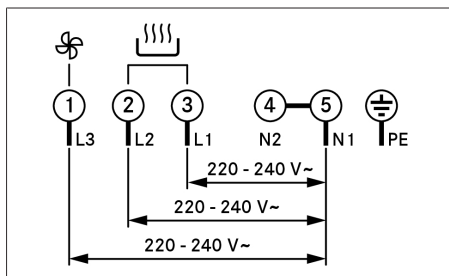

Fig. 9.38 Connection diagram - three-phase connection

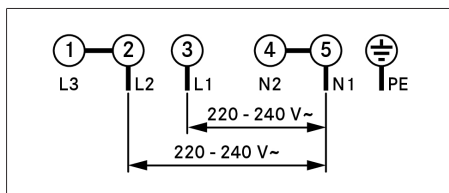

Fig. 9.39 Connection diagram - two-phase connection

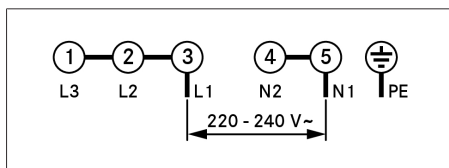

Fig. 9.40 Connection diagram - one-phase connection

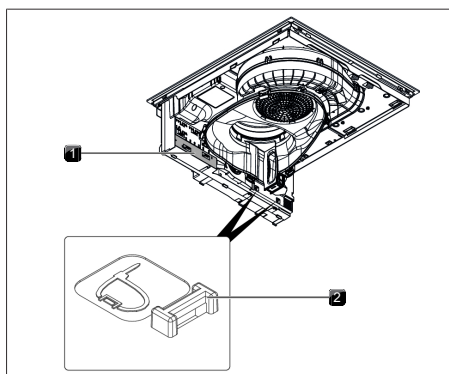

Fig. 9.41 Electrical connections of the cooktop

- [1] Power supply cover
- [2] Mounting eyes

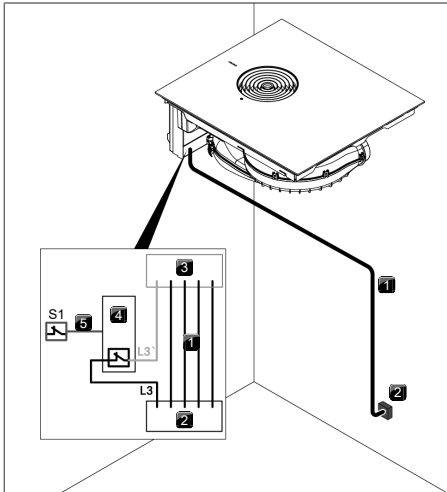

Fig. 9.42 Connection diagram with external switch contacts

- [1] Cooktop and cooktop extractor power supply cable
- [2] Power supply
- [3] Cooktop and cooktop extractor power supply
- [4] Switch relay
- [5] Switch connection S1 and switch relay
- [S1] External switch contact

9.9 Initial operation

- i** During initial operation some basic settings (basic configuration) must be applied using the dealer and service menu.

9.9.1 Dealer and service menu

- i** The dealer and service menu can be called up up to 2 minutes after the appliance has been connected to the power supply.
- i** The system adopts and saves the settings made when you exit the corresponding menu item.
- i** Below you will find explanations on how to use the menu and a description of the most important menu items.

Dealer and service menu overview

Menu item/Description/ Selection area	Factory setting
B Extraction system (exhaust air/ recirculation system)	Recirculation
C Power management	
D Demo mode	Off

Tab. 9.3 Menu overview

Calling up the dealer and service menu

- ▶ Connect the appliance to the power supply.
 - The standard display appears and the fan symbol pulses for 2 minutes.
- ▶ Long press on the fan button
- 4 input points
- ▶ Keep the fan button
- Menu item B is displayed.

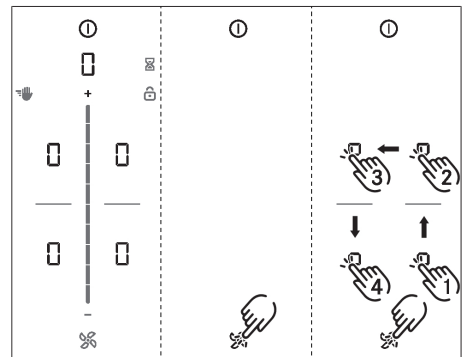

Fig. 9.43 Calling up the dealer and service menu

9.9.2 Menu item B: Extraction system configuration

The extraction system must be configured. There are two operating modes to choose from:

- Operating model: recirculation system (factory setting)
- Operating mode

- ▶ Select the corresponding operating mode (tap the corresponding segment on the slider).
- ▶ Confirm and save the setting by moving to the next menu item (tap the multi-function display/indicator b).

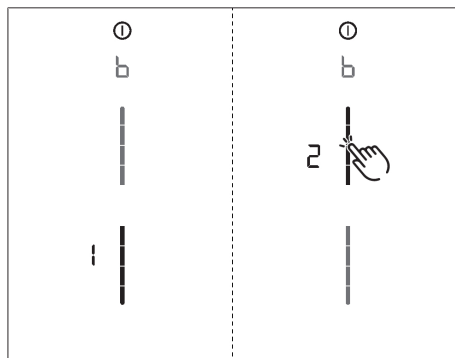

Fig. 9.44 Display Menu item B: Configuring the extraction system

9.9.3 Menu item C: Power management

The total appliance power can be reduced if the required electrical power cannot be provided at the installation site.

There are three operating modes to choose from:

Power management	Connection	Maximum power consumption	Fuse protection
C3	three-phase	7250 W	3 x 16 A
C3	two-phase	7250 W	2 x 16 A
C3	single-phase	7250 W	1 x 32 A
C2	single-phase	4400 W	1 x 20 A
C1	single-phase	3600 W	1 x 16 A

Tab. 9.4 Power management

- ▶ Select the corresponding operating mode (tap the corresponding segment on the slider).
- ▶ Confirm and save the setting by moving to the next menu item (tap the multi-function display/indicator c).

- i** The cooking zone power restrictions automatically implemented by the appliance are determined according to the total power set.

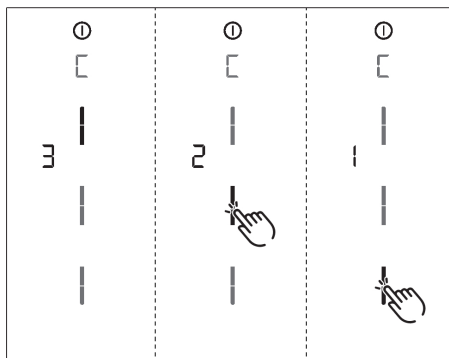



Fig. 9.45 Display menu item C: Power management

9.9.4 Menu item D: demo mode

The appliance can be set to demo mode, which includes all operating functions, but the heating function of the cooktops is deactivated.

- ▶ Tap the top slider segment.
- The demo mode symbol  is displayed on all cooking zones for one second.
-  is displayed.
- ▶ Confirm and save the setting by moving to the next menu item (tap the multi-function display/indicator d).

Closing the dealer and service menu

When you have been through all of the basic configuration menu items:

- ▶ long press on the multi-function display.
- ▶ The standard display appears.

- i** Pan size recognition is deactivated in demo mode.

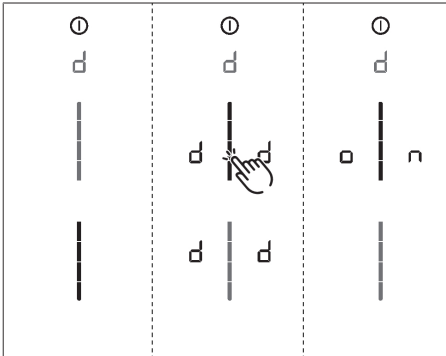

Fig. 9.46 Display Menu item D: demo mode

9.11 Handover to user

Once installation is complete:

- ▶ Explain the main functions to the user.
- ▶ Explain all safety-related aspects of operation and handling to the user.
- ▶ Provide the user with the accessories and operating and installation instructions, which are to be kept in a safe place.

9.9.5 Function test

- ▶ Carry out a thorough function test on all appliances.
- ▶ In the event of error messages, see the “Troubleshooting” chapter.

9.10 Sealing the appliance

- ▶ Once all of the installation work is complete, seal the appliance with black, heat-resistant silicone sealant.
- ▶ Make sure that no silicone sealant gets under the cooktop.

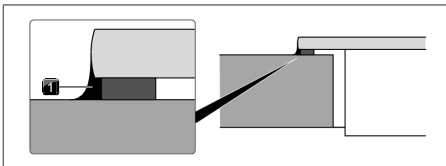

Fig. 9.47 Silicone sealant for surface mounting

- [1] Black, heat-resistant silicone sealant

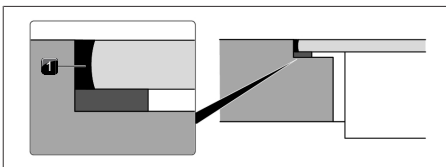

Fig. 9.48 Silicone sealant for flush installation

- [1] Black, heat-resistant silicone sealant

10 Decommissioning, disassembly and disposal

- ▶ Observe all safety and warning information (see "2 Safety").
- ▶ Follow the enclosed manufacturer's information.

10.1 Decommissioning

Decommissioning refers to ultimate decommissioning and disassembly. Following decommissioning, the appliance can either be installed in another unit, sold on privately or disposed of.

- i** The electricity and gas connections may only be disconnected and cut off by certified specialists.

- ▶ Switch the appliance off before decommissioning (see operating instructions)
- ▶ Disconnect the appliance from the power supply.
- ▶ Disconnect the appliance from the gas supply.

10.2 Disassembly

To be removed, the appliance must be accessible for disassembly and disconnected from the power supply.

- ▶ In the case of gas appliances, it must be ensured that the gas is disconnected.
- ▶ Remove the appliance fastenings.
- ▶ Remove the silicone seals.
- ▶ Disconnect the appliance from the exhaust duct.
- ▶ Lift the appliance up and out through the top of the worktop.
- ▶ Remove any other accessories.
- ▶ Dispose of the old appliance and any soiled accessories as described under "Environmentally-friendly disposal".

10.3 Environmentally-friendly disposal

10.3.1 Disposal of transport packaging

- i** The packaging protects the appliance from damage during transport. The packaging materials have been selected taking into account the environment and their disposal and are therefore recyclable.

Recycling the packaging saves raw materials and reduces waste. Your specialist retailer will take the packaging back.

- ▶ Give the packaging to your specialist retailer or
- ▶ dispose of the packaging correctly observing regional regulations.

10.3.2 Disposal of accessories

Dispose of unnecessary or used accessories (activated charcoal filters, etc.) accordingly taking into account the regional regulations.

10.3.3 Disposal of the old appliance



Electrical appliances with this mark must not be disposed of in the household waste at the end of their service life. They must be disposed of at a collection point for the recycling of electrical or electronic appliances. Information on this can be obtained from the city or local councils.

Waste electrical and electronic appliances often still contain valuable materials. However, they also contain harmful substances that were necessary to make them work and ensure their safety. If placed in the household waste or handled incorrectly, they may harm human health and damage the environment.

- ▶ Never dispose of your old appliance in the household waste.
- ▶ Take the appliance to a regional collection point for the return and further processing of electrical and electronic components and other materials.

11 Warranty, technical service, spare parts, accessories

- Observe all safety and warning information (see "2 Safety").

11.1 BORA manufacturer's warranty

BORA provides its end customers with a 2-year manufacturer's warranty for its products. The end customer is entitled to this warranty in addition to the statutory claims for defects against the sellers of our products.

The manufacturer's warranty applies to the BORA products listed here, which are sold by authorised BORA retailers or by BORA trained salespersons and are installed within the European Union (overseas territories excluded), Switzerland, Liechtenstein, Ukraine, Russia, Norway, Serbia, Israel, UK, Iceland, India, Australia and New Zealand, with the exception of BORA products labelled as universal or accessories:

- Cooktops
- Cooktop extractor systems
- Fans

The manufacturer's warranty starts as soon as the BORA product is handed over to the end customer and is valid for 2 years. Registering on www.mybora.com enables the manufacturer's warranty to be extended to 3 years.

The manufacturer's warranty requires expert installation (in accordance with the valid BORA ventilation handbook and operating instructions at the time of installation) of the BORA products by an authorised BORA retailer. During use, the end customer is to adhere to the specifications and instructions in the operating manual.

When filing a warranty claim, BORA must be directly notified of the fault and the receipt must be presented. Alternatively, proof of purchase can be provided by registering on www.mybora.com.

BORA guarantees that all BORA products are free from material and production defects. The defect must exist prior to delivery of the product to the end customer.

Filing a warranty claim does not interrupt the warranty period, nor shall the period start anew.

BORA will correct defects in BORA products at its own discretion by repairing or replacing the product. All costs for the correction of defects under the manufacturer's warranty shall be assumed by BORA appears in the cooktop extractor control knob display.

Expressly not covered by the BORA manufacturer's warranty are:

- BORA products that were not sold by authorised BORA dealers or salespersons trained by BORA
- Damage caused by non-adherence to the operating instructions (including product care and cleaning). This represents improper use.
- Damage caused by normal use, e.g. traces of usage on the cooktop
- Damage caused by external influences (such as transport damage, ingress of condensation, damage caused by the elements such as a lightning strike)
- Damage caused by repairs or repair attempts that were not carried out by BORA or by persons authorised by BORA .
- Damage to the glass ceramic
- Injury caused by electrical voltage fluctuations
- Secondary damage or claims for damages beyond the defect
- Damage to plastic parts

Legal claims, particularly statutory claims for defects or product liability are not limited by the warranty and can be asserted free of charge.

If a defect is not covered by the manufacturer's warranty, a claim may be made against the BORA Technical Service.

. BORA shall not assume the resulting costs.

The laws of the Federal Republic of Germany apply to these warranty conditions.

You can contact us at:

BORA Vertriebs GmbH & Co KG, Innstraße 1, 6342 Niederndorf, Austria

- Telephone: +800 7890 0987

Monday to Thursday from 8 a.m. to 6 p.m. and Friday from 8 a.m. to 5 p.m.

- Email: info@bora.com

11.1.1 Warranty extension

You can extend the warranty by registering at www.bora.com/registration.

11.2 Service

BORA Service:

see reverse side of operating and assembly instructions



- ▶ In the case of faults you cannot fix yourself, contact your BORA specialised retailer or the BORA Service Team appears in the cooktop extractor control knob display.

The BORA Service Team will require the type designation and serial number of your appliance (FD number).

This information is provided on the nameplate on the warranty form as well as on the bottom of the appliance.

11.3 Spare parts

- ▶ Only use original spare parts for repairs.
- ▶ Repairs may only be carried out by the BORA Service Team.

i Spare parts can be obtained from your BORA dealer, the BORA online service website at www.bora.com/service or by calling the service number provided.

11.4 Accessories

- Stainless steel grease filter PUEF
- Air inlet nozzle black PUED
- Air inlet nozzle greige PUEDG
- Air inlet nozzle red PUEDR
- Air inlet nozzle jade green PUEDJ
- Air inlet nozzle orange PUEDO
- Air inlet nozzle blue PUEDB
- Air inlet nozzle light grey PUEDL
- Air inlet nozzle sun yellow PUEDS

- Trim USL515
- Trim All Black USL515AB
- Glass ceramic scraper UGS

Special accessories PURSA:

- Window contact switch UFKS
- Air purification box PULB (for conversion from exhaust air to recirculation)

Special accessory PURSU:

- Activated charcoal filter PUAKEF

12 Energy data sheets

12.1 Energy data sheet for PURSA

Product information according to Commission Delegated Regulation (EU) No. 65/2014 and Regulation (EU) No. 66/2014.

Manufacturer		BORA	
Model identification		PURSA	
	Symbol	Value	Unit
Energy consumption			
Yearly power consumption	AEC_{hood}	32.4	kWh/a
Energy efficiency class	-	A+	-
Energy efficiency index	EEl_{hood}	42.5	-
Flow volume			
Fluid dynamic efficiency	FDE_{hood}	33.0	-
Fluid dynamic efficiency class	-	A	-
Minimum air flow during normal operation	-	171.6	m ³ /h
Maximum air flow during normal operation	-	543.0	m ³ /h
Maximum air flow when operated on the intensive level or fast mode level (power setting)	Q_{max}	608.0	m ³ /h
Measured air flow rate at the best efficiency point	Q_{BEP}	292.4	m ³ /h
Measured pressure at the best efficiency point	P_{BEP}	450.7	Pa
Measured electric power input at the best efficiency point	W_{BEP}	111.0	W
Time increase factor	f	0.8	-
Lighting			
Lighting efficiency	LE_{hood}	*	lx/W
Lighting efficiency class	-	*	-
Nominal power of the lighting system	W_L	*	W
Average lighting system illumination level on the cooking surface	E_{middle}	*	lx
Grease filtering			
Grease filtering efficiency	GFE_{hood}	95.2	%
Grease filtering efficiency class	-	A	-
Noise level			
A-rated airborne noise emission at minimum available speed in normal operation	-	39.4	dB(A) re_1pW
A-rated airborne noise emission at maximum available speed in normal operation	-	65.5	dB(A) re_1pW
A-rated airborne noise emission when operating on the intensive level or fast mode level (power setting)	-	67.9	dB(A) re_1pW

Manufacturer		BORA	
Model identification		PURSA	
Sound pressure level at minimum available speed in normal operation**	-	26.4	LpA in dB re 20 µPa
Sound pressure level at maximum available speed in normal operation**	-	52.5	LpA in dB re 20 µPa
Sound pressure level when operating on the intensive level or fast mode level (power setting)**	-	54.9	LpA in dB re 20 µPa
Power consumption			
Power consumption in off mode	P _o	0.14	W
Power consumption in standby mode	P _s	*	W

Tab. 12.1 Energy labelling

* Does not apply to this product.

** Voluntary declaration

The sound pressure level has been determined from a distance of 1 m (distance-dependent level recording) on the basis of the sound power level established under EN 60704-2-13.

12.2 Energy data sheet for S Pure

Product information according to Commission Delegated Regulation (EU) No. 65/2014 and Regulation (EU) No. 66/2014.

Manufacturer		BORA	
Model identification		PURSA/PURSU	
Type of hob		Glass ceramic cooktop	
	Symbol	Value	Unit
Heating technology	-	Induction cooking zone	-
Number of cooking zones	-	4	-
Front left cooking zone	∅	-	cm
Front right cooking zone	∅	21	cm
Rear left cooking zone	∅	14	cm
Rear right cooking zone	∅	17.5	cm
Front left cooking zone	EC _{electric cooking}	not applicable	Wh/kg
Front right cooking zone	EC _{electric cooking}	189.3	Wh/kg
Rear left cooking zone	EC _{electric cooking}	194.2	Wh/kg
Rear right cooking zone	EC _{electric cooking}	182.5	Wh/kg
Power consumption of the hob per kg	EC _{electric hob}	188.7	Wh/kg

Tab. 12.2 Energy data sheet for S Pure

DE Bedienungs- und Montageanleitung: Original Übersetzung**Hersteller: BORA Vertriebs GmbH & Co KG**

Weitergabe sowie Vervielfältigung dieser Unterlage, Verwertung und Mitteilung ihres Inhalts sind nicht gestattet, soweit nicht ausdrücklich zugestanden.

Bei der Erstellung dieser Bedienungs- und Montageanleitung wurde mit größter Sorgfalt gearbeitet. Dennoch kann es passieren, dass nachträgliche technische Änderungen noch nicht ergänzt bzw. entsprechende Inhalte noch nicht angepasst wurden. Wir bitten dies zu entschuldigen. Eine aktualisierte Version kann über das BORA Service Team angefordert werden. Druckfehler und Irrtümer vorbehalten.

© BORA Vertriebs GmbH & Co KG

Alle Rechte vorbehalten.

EN Operating and installation instructions: Original Translation**Manufacturer: BORA Vertriebs GmbH & Co KG**

The distribution and duplication of this document, as well as the use and disclosure of its contents are prohibited unless expressly authorised.

Great care was taken when devising these operating and installation instructions. However, it may be the case that later technical changes have not yet been added or the corresponding contents have not yet been modified. We apologise for this. An up-to-date version can be requested from the BORA Service team. Misprints and errors excepted.

© BORA Vertriebs GmbH & Co KG

All rights reserved.

ES Instrucciones de uso y montaje: Original Traducción**Fabricante: BORA Vertriebs GmbH & Co KG**

Queda prohibida la transmisión y la reproducción de esta documentación, así como el uso y divulgación de su contenido sin autorización expresa.

El presente manual de instrucciones de uso y montaje se ha elaborado con la máxima atención y cuidado. No obstante, puede ocurrir que no haya sido completado o que sus contenidos no se hayan adaptado tras modificaciones técnicas posteriores. Le rogamos disculpas en este caso. Puede solicitar una versión actualizada al equipo de BORA Service. Errores tipográficos y de imprenta reservados.

© BORA Vertriebs GmbH & Co KG

Todos los derechos reservados.

FR Notice d'utilisation et de montage: Original Traduction**Fabricant: BORA Vertriebs GmbH & Co KG**

Toute communication et reproduction de ce document, toute exploitation et communication de son contenu sont interdites, sauf autorisation expresse.

L'élaboration de la présente notice d'utilisation et de montage a été réalisée avec le plus grand soin. Il se peut pourtant que certaines modifications techniques n'aient pas encore été mises en œuvre et que le contenu n'ait par conséquent pas encore été adapté. Nous vous prions de bien vouloir nous en excuser. Une version à jour peut être obtenue auprès de l'équipe du service technique de BORA. Sous réserve d'erreurs de contenu ou d'impression.

© BORA Vertriebs GmbH & Co KG

Tous droits réservés.

IT Istruzioni per l'uso e il montaggio: Originale Traduzione**Produttore: BORA Vertriebs GmbH & Co KG**

Se non espressamente consentito, non sono ammesse la comunicazione e la duplicazione dei presenti allegati, così come il riutilizzo e la diffusione dei loro contenuti.

Nella stesura delle presenti Istruzioni per l'uso e il montaggio è stata applicata la massima cura. Tuttavia è possibile che modifiche tecniche ovvero che determinati contenuti non siano ancora stati adeguati. Chiediamo la vostra comprensione in merito. Una versione aggiornata può essere richiesta tramite il team di assistenza BORA. Con riserva di errori di stampa e altri errori.

© BORA Vertriebs GmbH & Co KG

Tutti i diritti riservati.



003284-10003



BORA Lüftungstechnik GmbH

Rosenheimer Str. 33
83064 Raubling
Deutschland
T +49 (0) 8035 / 9840-0
F +49 (0) 8035 / 9840-300
info@bora.com
bora.com



BORA Vertriebs GmbH & Co KG

Innstraße 1
6342 Niederndorf
Österreich
T +43 (0) 5373 / 62250-0
F +43 (0) 5373 / 62250-90
mail@bora.com
bora.com



BORA Holding GmbH

Innstraße 1
6342 Niederndorf
Austria
T +43 (0) 5373 / 62250-0
F +43 (0) 5373 / 62250-90
mail@bora.com
bora.com



BORA APAC Pty Ltd

100 Victoria Road
Drummoyne NSW 2047
Australia
T +61 2 9719 2350
F +61 2 8076 3514
info@boraapac.com.au
bora-australia.com.au

